



 HIGHFIELD 2023

#DARETOEXPLORE





# #DARETOEXPLORE WITH HIGHFIELD...

With around 46,000 boats delivered globally since the brand's beginning in 2011, Highfield Boats is now the world's number one in the RIB tender sector and a global player in the 5 metre + sector.

Performance and strength have always been at Highfield's core. The brand has focussed on these two key values above anything else. Highfield's hulls are dry-riding, very seaworthy and always over-built. Their reputation for durability is now world-renowned. The heavy-duty approach to design and build allows both leisure and commercial owners to have the confidence needed to go that extra mile and to tackle conditions avoided by many others.

As such, Highfield has been chosen time and again as the support boat of choice for prestigious events worldwide, with fleets up to 50 strong. From Vendee Globe to the Invictus Games, Pan Am Games, Extreme Sailing Series, ORC Championships, TP52 & The Route Du Rhum. Not only is this trust shown in Highfield's larger RIBs, but in their tenders too. Tender supply contracts to the likes of Lagoon paved the way for Highfield to become the supplier of choice for many charter operators, rental fleets and other high-end shipyards such as Fountaine Pajot, Outremer and Leopard.

Sustainability is also a huge part of Highfield's DNA. All of the hulls and structures are built in aluminium, which is infinitely recyclable. In addition, Highfield powder coat in an enclosed area to ensure that their footprint remains low from the beginning of the manufacturing process through to the end of each product's life.

With now over 45 distributor countries and a worldwide dealer network, you can be confident any support you need will always be on hand.



# CONTENTS

<b>Brand Timeline</b> .....	4
<b>Ultralite Range</b> .....	5-6
<b>Classic Range Overview</b> .....	7
<b>Classic 260 &amp; 290</b> .....	8
<b>Classic 310 &amp; 340</b> .....	9
<b>Classic 360 &amp; 380</b> .....	10
<b>Classic Console Options</b> .....	11
<b>Classic 420 &amp; 460</b> .....	12
<b>Sport Range Overview</b> .....	13
<b>Sport 300, 330 &amp; 360</b> .....	14
<b>Sport 390, 420 &amp; 460</b> .....	15
<b>Sport 520</b> .....	16
<b>Sport 560</b> .....	17
<b>Sport 600</b> .....	18
<b>Sport 660</b> .....	19
<b>Sport 700</b> .....	20
<b>Sport 760</b> .....	21
<b>Sport 900</b> .....	22
<b>Patrol Range Overview</b> .....	23
<b>Patrol 420 &amp; 460</b> .....	24
<b>Patrol 500</b> .....	25
<b>Patrol 540</b> .....	26
<b>Patrol 600</b> .....	27
<b>Patrol 660</b> .....	28
<b>Patrol 700</b> .....	29
<b>Patrol 760</b> .....	30
<b>Patrol 860</b> .....	31
<b>Render Bank / Colour Schemes</b> .....	32-33





2011



Brand created with an Australian design and expertise, French/ Chinese ownership. First boat show in La Rochelle.

'12

Distributor group grows. First Distributor meeting takes place in Weihai

'13

Highfield Boats enters into an alliance with Honda Marine throughout Key EU markets

'13

Highfield enters the smallest vessels into the 1100 Nautical Mile "Round Ireland Challenge"

'15

Highfield Supports Pan Am games in Toronto

'16

Highfield Boats supplies 50 security RIBs to the Vendee Globe Organisation for the start and finish of VG 2016

'16

Highfield enters into partnership with OC Sport and supplies a fleet to The Extreme Sailing Series

'17

Highfield supplies the support fleet for TP52 racing fleet & ORC World Championships in Croatia

'18

Highfield supplies support fleet for the Invictus Games

'18

Highfield supplies 50 vessels to OC Sport for the start of Route Du Rum in St Malo, France

'18

Highfield takes direct control of its United States operation

'19

Highfield Partners with Alex Thomson Racing and supports Hugo Boss through the IMOCA Globe series campaign

'20

Highfield Once again supplies the 50 boat support and safety fleet for Vendee Globe

'20

Highfield launches the Sport range

'21

Highfield takes direct control of its Australia operation

2022

Highfield Supplies once again 50 vessels for the security of Route Du Rhum and partners with OC Sport





# THE A S U

# THE U

Ultralite Range are single deck dinghies, created always keeping weight in mind. Their light weight make them a real alternative for those who may have chosen a soft bottom tender in the past but would prefer a hard hull for its performance.

Ultralite tenders are roomy and strong, yet light and easy to transport. These little boats can be launched and recovered by a single man and are easy to be transported on a roof rack. The Ultralite's are made of 2.5mm thick powder coated marine grade aluminium for the hull and 1100 Dtex fabric for the inflatable tube.

**BECAUSE  
WEIGHT  
DOES  
MATTER**



# ULTRALITE RANGE

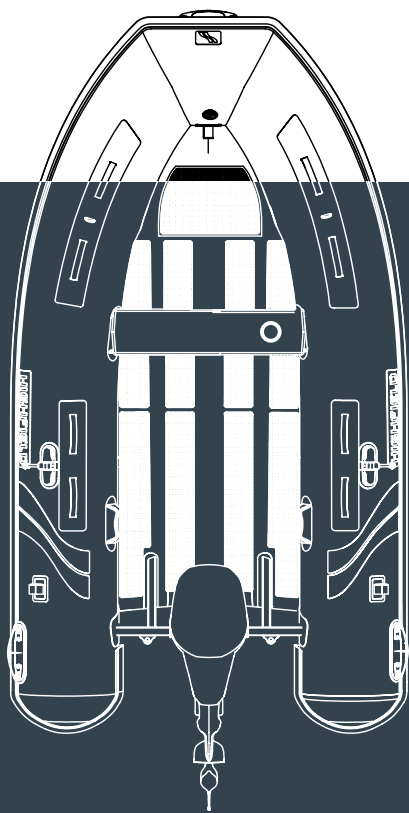

	VL220		VL240		VL260		VL290		VL310		VL340	
<b>OVERALL LENGTH</b>	220cm	7'3"	240cm	7'10"	260cm	8'6"	290cm	9'6"	313cm	10'3"	337cm	11'1"
<b>INTERNAL LENGTH</b>	145cm	4'9"	164cm	5'4"	184cm	6'	214cm	7'	224cm	7'4"	243cm	8'
<b>OVERALL WIDTH</b>	152cm	5'	154cm	5'1"	154cm	5'1"	154cm	5'1"	172cm	5'8"	172cm	5'8"
<b>INTERNAL WIDTH</b>	75cm	2'6"	78cm	2'7"	77cm	2'6"	77cm	2'6"	79cm	2'7"	79cm	2'7"
<b>DEADRISE</b>	10.5"		10.5"		10.5"		15"		15"		15"	
<b>TUBE DIAMETER *</b>	38cm	15"	38cm	15"	38cm	15"	38cm	15"	44cm	17"	44cm	17"
<b>NUMBER OF AIR CHAMBERS</b>	3		3		3		3		3		3	
<b>MAXIMUM LOAD</b>	296kg	653lbs	296kg	653lbs	340kg	750lbs	375kg	827lbs	585kg	1290lbs	663kg	1462lbs
<b>MAXIMUM PEOPLE</b>	3		3		3+1		4		5		5+1	
<b>BOAT WEIGHT **</b>	30kg	65lbs	33kg	72lbs	35kg	77lbs	39kg	86lbs	50kg	110lbs	53kg	117lbs
<b>MAXIMUM POWER</b>	5hp		6hp		6hp		10hp		15hp		20hp	
<b>ENGINE SHAFT</b>	S		S		S		S		S		S	
<b>DESIGN CATEGORY</b>	C		C		C		C		C		C	

\* larger tube diameters available \*\* boat only

## COLOUR SCHEMES



### STANDARD FEATURES

- ORCA® Hypalon or PVC tube
- Welded seams (PVC)
- Flush mount non-return valves
- High tensile chromated & powder coated aluminum hull
- Removable seat
- Lifting points and towing eyes
- Low bridle points
- Anti-slip deck
- Light weight rubbing strake
- Full length keel guard
- Under seat bag
- Highfield dry bag
- Foot pump, oars, repair kit
- EVA

### OPTIONAL EXTRAS

- Extra seat
- Boat cover







**T H E**

**C**

Classic Range offers extra levels of comfort in this double deck hulled dinghy that will keep your feet dry. The hulls of the Classics are built of 2.5mm thick powder coated marine grade aluminium. The tubes are made of 1100 dtex coated fabric.

The high quality finish and luxury look belies the fact that this range of tenders has been designed to work hard. A durable aluminium hull coupled with full length keel guards make these ideal for those beach-hopping days with friends and family.

The optional FCT console or GT console options allow forward steering control for increased comfort and greater ease of navigation. These options offer a more luxurious tender experience whilst still keeping the weight down.

The large weight savings achieved compared to equivalent GRP tenders means you'll enjoy impressive performance with smaller engines. All of this combined with excellent payload capacities means the Classic range really does offer a tender for everyone.



# CLASSIC 260 & 290

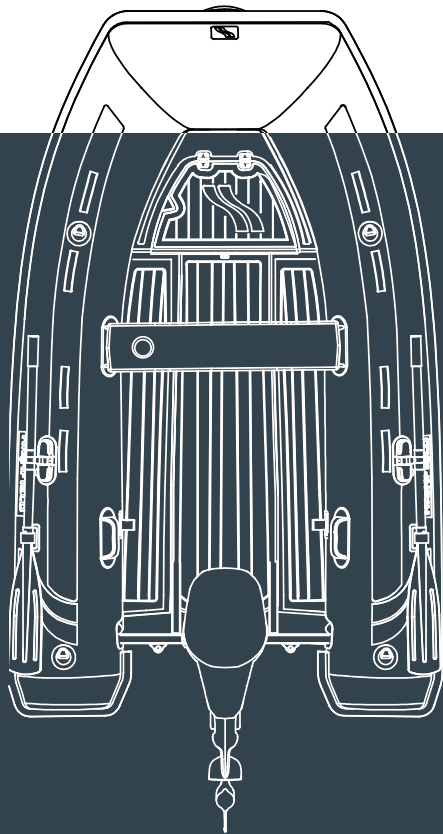

## STANDARD FEATURES

- ORCA® Hypalon or PVC tube
- Welded seams (PVC)
- Flush mount non-return valves
- High tensile chromated & powder coated aluminum hull
- Bow locker (Fit 24L fuel tank)
- Integrated transom supports
- Removable seat
- Lifting points and towing eyes
- Tow bridle points
- Brushed foam teak finish deck
- Heavy duty rubbing strake
- Full length keel guard
- Tank strap kit
- Under seat bag
- Highfield dry bag
- Foot pump, oars, repair kit

## OPTIONAL EXTRAS

- FRP Bow Step
- Molded bow cleat
- Bow cushion
- Boat cover

## COLOUR SCHEMES



	CL260		CL290	
<b>OVERALL LENGTH</b>	260cm	8'6"	290cm	9'6"
<b>INTERNAL LENGTH</b>	176cm	5'9"	206cm	6'9"
<b>OVERALL WIDTH</b>	170cm	5'7"	170cm	5'7"
<b>INTERNAL WIDTH</b>	79cm	2'7"	79cm	2'7"
<b>DEADRISE</b>	15°		15°	
<b>TUBE DIAMETER</b>	44cm	17"	44cm	17"
<b>NUMBER OF AIR CHAMBERS</b>	3		3	
<b>MAXIMUM LOAD</b>	360kg	794lbs	480kg	1058lbs
<b>MAXIMUM PEOPLE</b>	3+1		4	
<b>BOAT WEIGHT*</b>	54kg	119lbs	59kg	130lbs
<b>MAXIMUM POWER</b>	15hp		20hp	
<b>ENGINE SHAFT</b>	S		S	
<b>DESIGN CATEGORY</b>	C		C	

\* boat only

THE COMPACT MODELS CAN CARRY 4 PEOPLE, MAKING THEM IDEAL FOR SHORT TRIPS. AGILE & STRONG OFFERING SLIGHTLY UP TO A 480KG PAYLOAD.





# CLASSIC 310 & 340

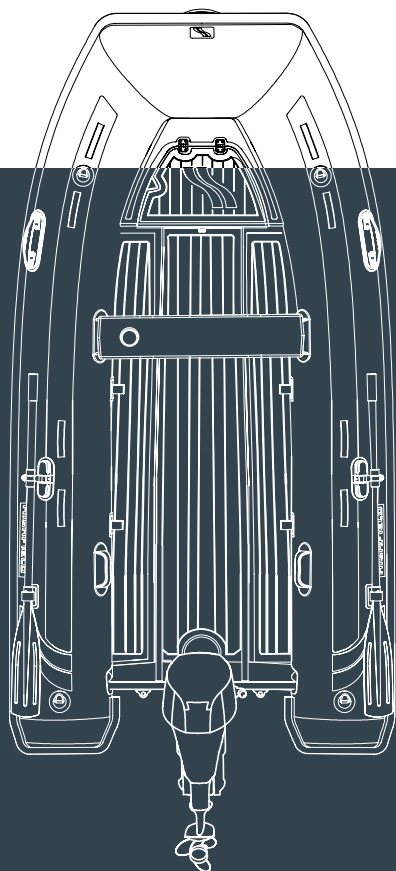

## STANDARD FEATURES

- ORCA® Hypalon or PVC tube
- Welded seams (PVC)
- Flush mount non-return valves
- High tensile chromated & powder coated aluminum hull
- Bow locker (Fit 24L fuel tank)
- Integrated transom supports
- Removable seat
- Lifting points and towing eyes
- Tow bridle points
- Brushed foam teak finish deck
- Heavy duty rubbing strake
- Full length keel guard
- Tank strap kit
- Under seat bag
- Highfield dry bag
- Foot pump, oars, repair kit

## COLOUR SCHEMES



	CL310		CL340	
<b>OVERALL LENGTH</b>	310cm	10'2"	340cm	11'2"
<b>INTERNAL LENGTH</b>	226cm	7'5"	247cm	8'1"
<b>OVERALL WIDTH</b>	170cm	5'7"	170cm	5'7"
<b>INTERNAL WIDTH</b>	79cm	2'7"	79cm	2'7"
<b>DEADRISE</b>	15°		15°	
<b>TUBE DIAMETER</b>	44cm	17"	44cm	17"
<b>NUMBER OF AIR CHAMBERS</b>	3		3	
<b>MAXIMUM LOAD</b>	550kg	1213lbs	551kg	1215lbs
<b>MAXIMUM PEOPLE</b>	5		6	
<b>BOAT WEIGHT**</b>	62kg	137lbs	71kgs	157lbs
<b>MAXIMUM POWER</b>	20hp		25hp	
<b>ENGINE SHAFT</b>	S		S	
<b>DESIGN CATEGORY</b>	C		C	

## OPTIONAL EXTRAS

- Console Options
- FRP Bow Step
- Molded bow cleat
- Bow cushion
- Boat cover

\*\* boat only



OUR EASY HANDLING 5 & 6 MAN MODELS ARE GREAT ALL-ROUNDERS. THE ALUMINIUM HULL FEATURES 3 LIFTING POINTS. THEY CAN BE FITTED WITH AN OPTIONAL CONSOLE TO MAKE IT EVEN EASIER RIDING. BOW LOCKER & FUEL TANK STORAGE AS STANDARD MAKE THIS A POPULAR CHOICE.



# CLASSIC 360 & 380

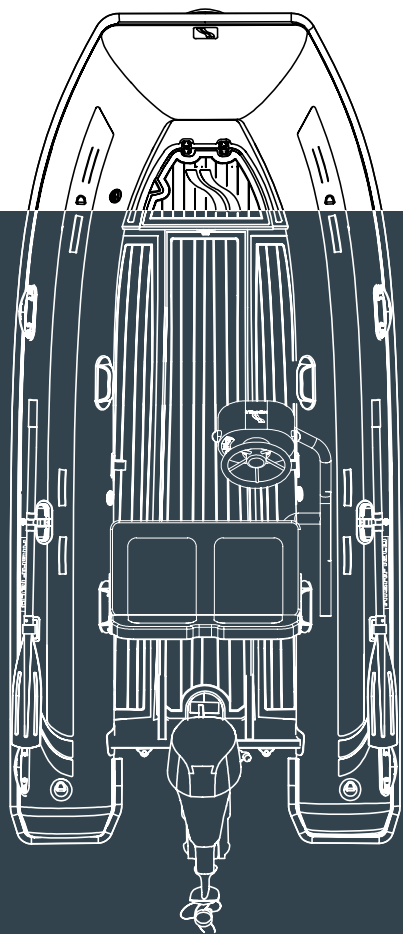

## STANDARD FEATURES

- ORCA® Hypalon or PVC tube
- Welded seams (PVC)
- Flush mount non-return valves
- High tensile chromated & powder coated aluminum hull
- Bow locker (Fit 24L fuel tank)
- Integrated transom supports
- Removable seat
- Lifting points and towing eyes
- Tow bridle points
- Brushed foam teak finish deck
- Heavy duty rubbing strake
- Full length keel guard
- Tank strap kit
- Under seat bag
- Highfield dry bag
- Foot pump, oars, repair kit

## COLOUR SCHEMES



C1360

C1380

<b>OVERALL LENGTH</b>	360cm	11'10"	380cm	12'6"
<b>INTERNAL LENGTH</b>	267cm	8'9"	287cm	9'5"
<b>OVERALL WIDTH</b>	170cm	5'7"	170cm	5'7"
<b>INTERNAL WIDTH</b>	79cm	2'7"	79cm	2'7"
<b>DEADRISE</b>	15°		15°	
<b>TUBE DIAMETER</b>	44cm	17"	44cm	17"
<b>NUMBER OF AIR CHAMBERS</b>	3		3	
<b>MAXIMUM LOAD</b>	561kg	1237lbs	637kg	1404lbs
<b>MAXIMUM PEOPLE</b>	6		7	
<b>BOAT WEIGHT*</b>	75kg	165lbs	83kg	183lbs
<b>MAXIMUM POWER</b>	30hp		30hp	
<b>ENGINE SHAFT</b>	S		S	
<b>DESIGN CATEGORY</b>	C		C	

## OPTIONAL EXTRAS

### Console Options

- FRP Bow Step
- Molded bow cleat
- Bow cushion
- Boat cover

\* boat only

THESE ROOMY MODELS COMBINE AN IMPRESSIVE PAYLOAD WITH GREAT HANDLING. FRONT LOCKER & FUEL TANK STORAGE AS STANDARD. OPTIONAL CONSOLE. PERFECT FOR LONGER DISTANCES OR LARGER LOADS.





# CONSOLE OPTIONS CLASSIC 310 & UP



11



## FCT CONSOLE

The FCT7 console package is a perfect addition to any Classic 310 up to Classic 380 model giving you an additional level of comfort and enjoyability for your day on the water. The rear bench seat with high backrest and closed cell foam cushions which won't hold water, are perfect for a comfortable day exploring. The console helm is an open style design giving you unprecedented legroom in a boat of its size while a carbon dash with LED switches and branded steering wheel add a dash of style. An electrical package including led flush mounted switch panel, navigation lights and bilge pump are all standard.

WEIGHT: 36kg / 80lbs    CAPACITY: 100l / 3.5 cu ft



## GT CONSOLE

The NEW "Grand Tour" GT version console option combines lightweight and performance of the Classic line but with more comfort and styling from the luxury Sport boats for a perfect combination of reliability and styling. The Classic GT is available for CL340 and up, turning the Classic into an easy handling runabout, perfect for having fun when you've anchored for lunch.

CONSOLE WEIGHT: 25.5kg / 56lbs    FOLDING SEAT WEIGHT: 20kg / 45lbs



# CLASSIC 420 & 460

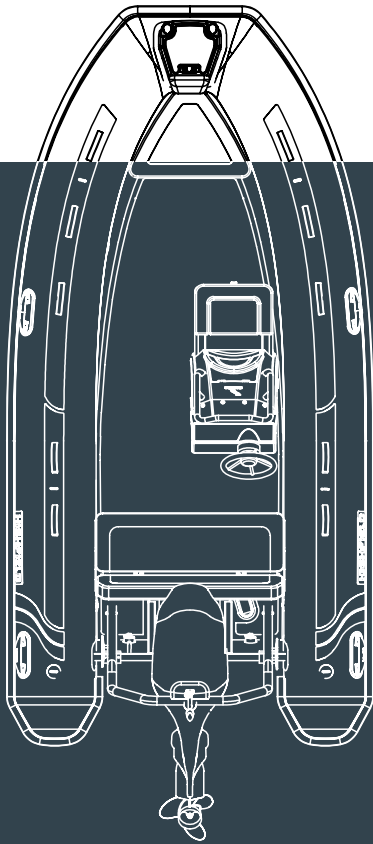

## STANDARD FEATURES

- ORCA® Hypalon or PVC tube
- Welded seams (PVC)
- Flush mount non-return valves
- High tensile chromated & powder coated aluminum hull
- Self-draining deck
- Bow locker
- Console & Seat
- Carbon dash for console
- FRP Bow Step & bow cushion
- Integrated transom supports
- Lifting points and towing eyes
- Tow bridle points
- Brushed foam teak finish deck
- Heavy duty rubbing strake
- Full length keel guard
- Tank strap kit
- Highfield dry bag
- Foot pump, oars, repair kit
- Electrical packs for boat & console

## OPTIONAL EXTRAS

- Roll bar
- Boat cover

\* boat only

## COLOUR SCHEMES



C420

C460

<b>OVERALL LENGTH</b>	421cm	13'10"	461cm	15'2"
<b>INTERNAL LENGTH</b>	317cm	10'5"	361cm	11'10"
<b>OVERALL WIDTH</b>	210cm	6'11"	209cm	6'10"
<b>INTERNAL WIDTH</b>	105cm	3'5"	108cm	3'7"
<b>DEADRISE</b>	20°		20°	
<b>TUBE DIAMETER</b>	47cm	19"	47cm	19"
<b>NUMBER OF AIR CHAMBERS</b>	4		5	
<b>MAXIMUM LOAD</b>	823kg	1814lbs	944kg	2081lbs
<b>MAXIMUM PEOPLE</b>	8		9	
<b>BOAT WEIGHT*</b>	204kg	450lbs	227kg	500lbs
<b>MAXIMUM POWER</b>	60hp		80hp	
<b>ENGINE SHAFT</b>	L		L	
<b>FUEL TANK (LITRES)</b>	40l		40l	
<b>DESIGN CATEGORY</b>	C		C	

LIGHTWEIGHT AND CAPABLE, THIS BOAT CAN BE BUILT TO SUIT YOUR TENDER REQUIREMENTS. THE LARGEST CLASSIC MODELS ARE VERY CAPABLE RIBS WITH EXCELLENT LAYOUT OPTIONS AND WILL SUIT MULTIPLE SITUATIONS. THE PERFECT BEACH HOPPER, GREAT TENDER OR EXCELLENT FAMILY DAY BOAT.







# THE SPORTS

port range of high quality boats offers a choice from 3 metres up to 9 metres and combines all of our hull design expertise with an interior that you demand.

Nothing has been sacrificed in the design of this range. Top quality materials are the hallmark of what we do and we have not compromised. Hull deadrise angles ranging from 20 degrees on the 3 metre going through to a huge 26 degrees on the 600 and up will give you assurance in the toughest conditions.

The additions such as EVA teak throughout, integrated fuel tanks, superb diamond stitched upholstery and bathing platforms on our larger models will allow you to enjoy each day to the maximum.

With the impermeable qualities of our aluminium hulls there's no need to worry about gel-coat chips, or putting the boat on a beach or trailer. All Highfield Sport RIBs are easy to tow, launch and recover due to their light weight and integrated davit lifting eyes. Your Sport will not delaminate or absorb water over time, retaining the same agile performance in 10 years time as the day you collected it.

The Highfield Boats Sport range offers the very best solution for your requirement. Low weight garage tender or runabout, through to an offshore mile crunching cruiser.



# SPORT 300-360

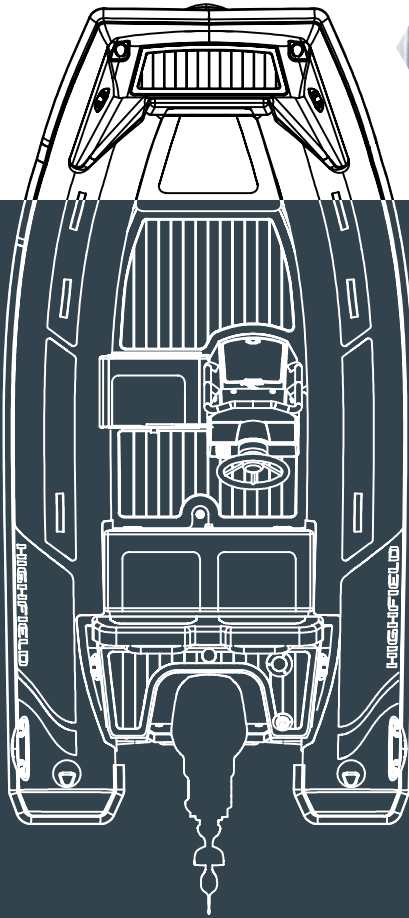

## STANDARD FEATURES

- ORCA® Hypalon or PVC tube
- Welded seams (PVC)
- Flush mount non-return valves
- High tensile chromated & powder coated aluminum hull
- Integrated rear seat with cushion

- Integrated transom supports
- Lifting points and towing eyes
- Brushed foam teak finish deck
- Heavy duty rubbing strake
- Keel guard
- Highfield dry bag
- Foot pump, oars, repair kit

- Electrical pack for boat & console
- Carbon dash for console

## OPTIONAL EXTRAS

- Boat cover
- Sundeck (330 up)
- Tow post (330 up)

	SP300		SP330		SP360	
OVERALL LENGTH	300cm	9'10"	336cm	11'	362cm	11'11"
INTERNAL LENGTH	180cm	5'11"	204cm	6'8"	236cm	7'9"
OVERALL WIDTH	183cm	6'	182cm	6'	184cm	6'
INTERNAL WIDTH	84cm	2'9"	90cm	2'11"	92cm	3'
DEADRISE	20°		20°		20°	
TUBE DIAMETER	43cm	17"	43cm	17"	43cm	17"
NUMBER OF AIR CHAMBERS	3		3		3	
MAXIMUM LOAD	464kg	1023lbs	549kg	1211lbs	634kg	1398lbs
MAXIMUM PEOPLE	4		5		6	
BOAT WEIGHT*	175kg	385lbs	199kg	439lbs	215kg	473lbs
MAXIMUM POWER	30hp		30hp		40hp	
ENGINE SHAFT	L		L		L	
FUEL TANK (LITRES)	N/A		30l		30l	

\* boat & console only

## COLOR SCHEMES



TRUE LIGHTWEIGHT LUXURY. OUR SMALLEST SPORT MODELS MAKE THE IDEAL TENDER, SMALL ENOUGH TO SIT ON THE BACK OF MOST CRUISERS. SMALL AND NIMBLE, BUT WITH ENOUGH ROOM TO CARRY EVERYTHING YOU NEED FOR A DAY ON THE WATER.



# SPORT 390-460

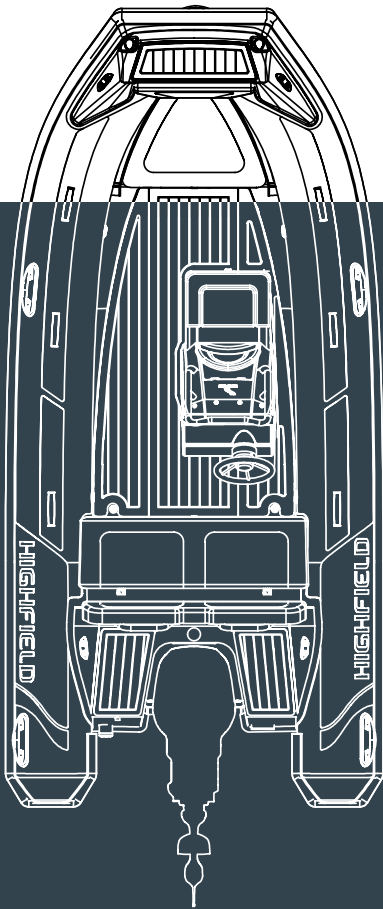

\* boat & console only



## STANDARD FEATURES

- ORCA® Hypalon or PVC tube
- Welded seams (PVC)
- Flush mount non-return valves
- High tensile chromated & powder coated aluminum hull
- Self-draining deck (SP420 up)
- Integrated rear seat with cushion

- Integrated transom supports
- Lifting points and towing eyes
- Brushed foam teak finish deck
- Heavy duty rubbing strake
- Keel guard
- Highfield dry bag
- Foot pump & repair kit
- Electrical pack for boat & console

- Carbon dash for console

## OPTIONAL EXTRAS

- Boat cover
- Sundeck
- Tow post
- Roll bar
- Forward arch

	SP390		SP420		SP460	
<b>OVERALL LENGTH</b>	390cm	12'10"	424cm	13'11"	460cm	15'1"
<b>INTERNAL LENGTH</b>	250cm	8'2"	272cm	8'11"	291cm	9'7"
<b>OVERALL WIDTH</b>	192cm	6'4"	205cm	6'9"	209cm	6'10"
<b>INTERNAL WIDTH</b>	92cm	3'	108cm	3'7"	108cm	3'7"
<b>DEADRISE</b>	20°		20°		20°	
<b>TUBE DIAMETER</b>	47cm	19"	47cm	19"	47cm	19"
<b>NUMBER OF AIR CHAMBERS</b>	3		4		5	
<b>MAXIMUM LOAD</b>	716kg	1579lbs	791kg	1744lbs	912kg	2011lbs
<b>MAXIMUM PEOPLE</b>	7		8		9	
<b>BOAT WEIGHT*</b>	226kg	497lbs	309kg	681lbs	332kg	731lbs
<b>MAXIMUM POWER</b>	60hp		70hp		90hp	
<b>ENGINE SHAFT</b>	L		L		L	
<b>FUEL TANK (LITRES)</b>	30l		55l		55l	



## COLOUR SCHEMES



THESE MODELS MAKE A PERFECT FAMILY DAYBOAT OR TENDER FOR A LARGER MOTOR CRUISER OR CATAMARAN. AMPLE STORAGE & OPTIONAL SUNDECK AND TOW POST.



# SPORT 520

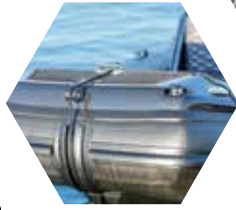
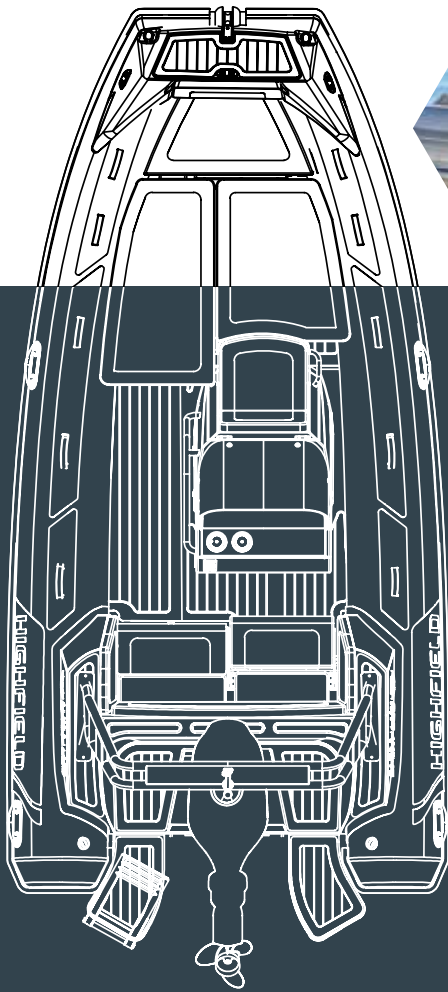

## STANDARD FEATURES

- ORCA® Hypalon or PVC tube
- Welded seams (PVC)
- Flush mount non-return valves
- High tensile chromated & powder coated aluminum hull
- Self-draining deck
- Integrated rear seat with cushion
- Integrated transom supports
- Lifting points and towing eyes
- Brushed foam teak finish deck
- Heavy duty rubbing strake
- Keel guard
- Highfield dry bag
- Foot pump & repair kit
- Electrical pack for boat & console
- Carbon dash for console
- Platform with ladder (520)

## OPTIONAL EXTRAS

- Boat cover
- Sundeck
- Tow post
- Roll bar
- Forward arch

\* boat & console only

## COLOUR SCHEMES



OVERALL LENGTH	523cm	17'2"
INTERNAL LENGTH	343cm	11'3"
OVERALL WIDTH	246cm	8'1"
INTERNAL WIDTH	130cm	4'3"
DEADRISE	24°	
TUBE DIAMETER	52cm	20"
NUMBER OF AIR CHAMBERS	6	
MAXIMUM LOAD	1058kg	2332lbs
MAXIMUM PEOPLE	10	
BOAT WEIGHT*	516kg	1136lbs
MAXIMUM POWER	100hp	
ENGINE SHAFT	L	
FUEL TANK (LITRES)	105l	



EXCELLENT INTERNAL STORAGE OPTIONS AND GREAT ERGONOMICS MAKE THESE MODELS A JOY TO DRIVE. A 105 LITRE FUEL TANK (SP520) GIVES YOU GREAT RANGE BETWEEN FUEL STOPS & THE TOW POST/ROLL BAR ALLOWS YOU TO PULL A WAKEBOARD WITH EASE.





# SPORT 560

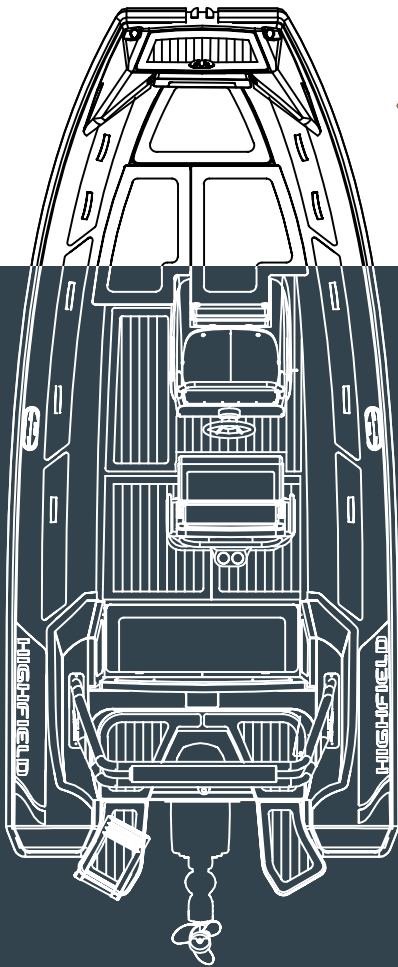

## STANDARD FEATURES

- ORCA® Hypalon or PVC tube
- Welded seams (PVC)
- Flush mount non-return valves
- High tensile chromated & powder coated aluminum hull
- Self-draining deck
- Integrated rear seat with cushion
- Integrated transom supports
- Lifting points and towing eyes
- Brushed foam teak finish deck
- Heavy duty rubbing strake
- Keel guard
- Highfield dry bag
- Foot pump & repair kit
- Electrical pack for boat & console
- Carbon dash for console
- Platform with ladder

## OPTIONAL EXTRAS

- Boat cover
- Sundeck
- Tow post
- Roll bar
- Bimini

## COLOUR SCHEMES



OVERALL LENGTH	566cm	18'7"
INTERNAL LENGTH	382cm	12'6"
OVERALL WIDTH	250cm	8'3"
INTERNAL WIDTH	135cm	4'5"
DEADRISE	24°	
TUBE DIAMETER *	52cm	20"
NUMBER OF AIR CHAMBERS	6	
MAXIMUM LOAD	1188kg	2619lbs
MAXIMUM PEOPLE	12	
BOAT WEIGHT **	581kg	1280lbs
MAXIMUM POWER	115hp	
ENGINE SHAFT	XL	
FUEL TANK	105l	
DESIGN CATEGORY	C	

\*smaller tube diameter available \*\* boat, console & standard seating only

ONE OF THE MOST VERSATILE MEDIUM SIZED RIBS IN ITS CLASS. IN ADDITION TO IT'S ACCLAIMED HULL DESIGN, SWIM PLATFORMS PORT AND STARBOARD AND OPTIONAL TOW POST MAKE THIS AN EXCELLENT WATER SPORTS PLATFORM FOR THE WHOLE FAMILY.





# SPORT 600

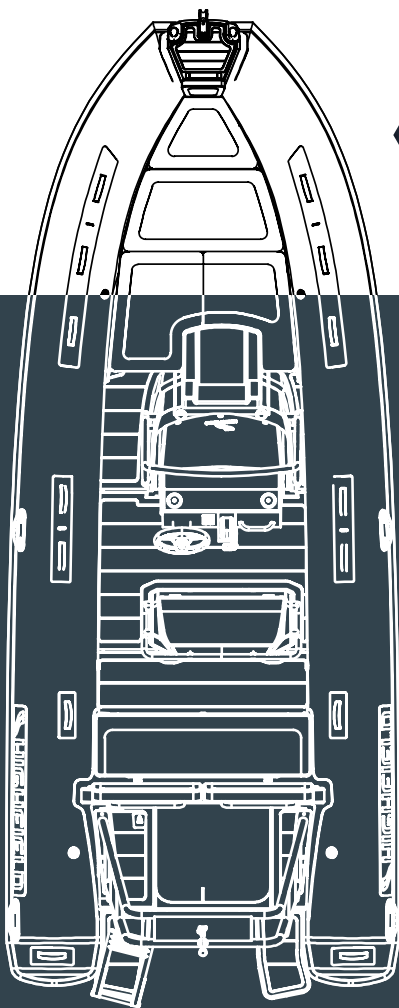

## STANDARD FEATURES

- ORCA® Hypalon or PVC tube
- Welded seams (PVC)
- Flush mount non-return valves
- High tensile chromated & powder coated aluminum hull
- Self-draining deck
- Integrated rear seat with cushion
- Integrated transom supports
- Lifting points and towing eyes
- Brushed foam teak finish deck
- Heavy duty rubbing strake
- Keel guard
- Highfield dry bag
- Foot pump & repair kit
- Electrical pack for boat & console
- Carbon dash for console
- Platform with ladder
- Sundeck
- Roll bar
- Shower kit

## OPTIONAL EXTRAS

- Bimini

## COLOUR SCHEMES



<b>OVERALL LENGTH</b>	616cm	20'3"
<b>INTERNAL LENGTH</b>	437cm	14'4"
<b>OVERALL WIDTH</b>	249cm	8'2"
<b>INTERNAL WIDTH</b>	132cm	4'4"
<b>DEADRISE</b>	26°	
<b>TUBE DIAMETER*</b>	56cm	22"
<b>NUMBER OF AIR CHAMBERS</b>	6	
<b>MAXIMUM LOAD</b>	1458kg	3214lbs
<b>MAXIMUM PEOPLE</b>	14	
<b>BOAT WEIGHT**</b>	694kg	1530kg
<b>MAXIMUM POWER</b>	150hp	
<b>ENGINE SHAFT</b>	XL	
<b>FUEL TANK</b>	140l	
<b>DESIGN CATEGORY</b>	C	

\*smaller tube diameter available \*\* boat, console, roll-bar & standard seating only



THIS POCKET, FAMILY OFFSHORE RIB OFFERS EXCEPTIONAL VALUE AND GREAT CAPABILITY



# SPORT 660

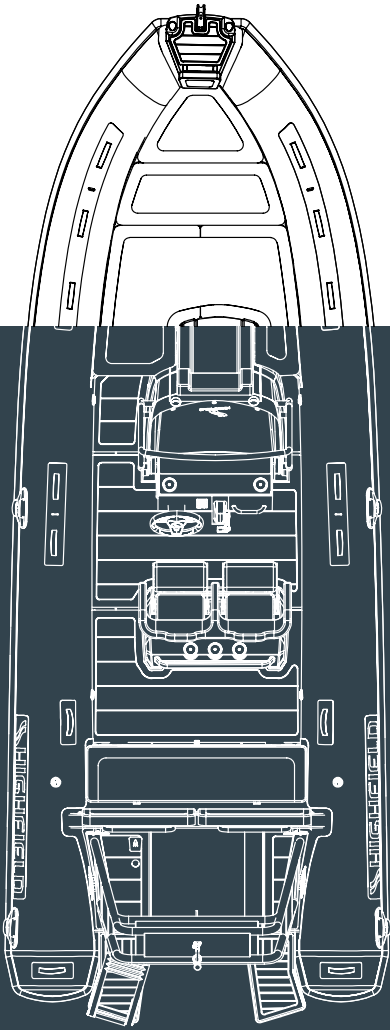

## STANDARD FEATURES

- ORCA® Hypalon or PVC tube
- Welded seams (PVC)
- Flush mount non-return valves
- High tensile chromated & powder coated aluminum hull
- Self-draining deck
- Integrated rear seat with cushion
- Integrated transom supports
- Lifting points and towing eyes
- Brushed foam teak finish deck
- Heavy duty rubbing strake
- Keel guard
- Highfield dry bag
- Foot pump & repair kit
- Electrical pack for boat & console
- Carbon dash for console
- Platform with ladder
- Sundeck
- Roll bar
- Shower kit

## OPTIONAL EXTRAS

- Bimini

## COLOUR SCHEMES



<b>OVERALL LENGTH</b>	651cm	21'4"
<b>INTERNAL LENGTH</b>	475cm	15'7"
<b>OVERALL WIDTH</b>	259cm	8'6"
<b>INTERNAL WIDTH</b>	135cm	4'5"
<b>DEADRISE</b>	26°	
<b>TUBE DIAMETER</b>	58cm	23"
<b>NUMBER OF AIR CHAMBERS</b>	6	
<b>MAXIMUM LOAD</b>	1287kg	2837lbs
<b>MAXIMUM PEOPLE</b>	13	
<b>BOAT WEIGHT*</b>	740kg	1631lbs
<b>MAXIMUM POWER</b>	200hp	
<b>ENGINE SHAFT</b>	XL	
<b>FUEL TANK</b>	140l	
<b>DESIGN CATEGORY</b>	C	

\* boat, console, roll-bar & standard seating only



OUR MID-SIZED FAMILY RIB WITH A SUPER DEEP-V HULL WILL ALLOW YOU TO EXPLORE FURTHER



# SPORT 700

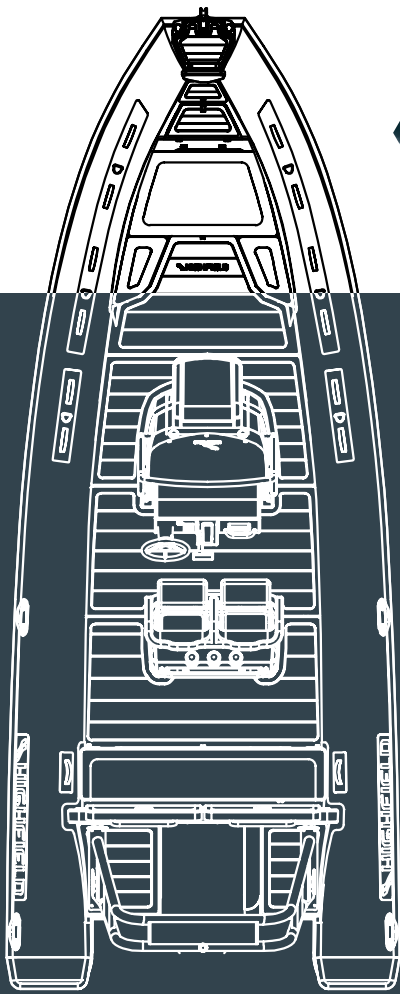

## STANDARD FEATURES

- ORCA® Hypalon or PVC tube
- Welded seams (PVC)
- Flush mount non-return valves
- High tensile chromated & powder coated aluminum hull
- Self-draining deck
- Integrated rear seat with cushion
- Integrated transom supports
- Lifting points and towing eyes
- Brushed foam teak finish deck
- Heavy duty rubbing strake
- Keel guard
- Highfield dry bag
- Foot pump & repair kit
- Electrical pack for boat & console
- Carbon dash for console
- Platform with ladder
- Sundeck
- Roll bar
- Shower kit

## OPTIONAL EXTRAS

- Bimini

## COLOUR SCHEMES



OVERALL LENGTH	719cm	23'7"
INTERNAL LENGTH	538cm	17'8"
OVERALL WIDTH	293cm	9'7"
INTERNAL WIDTH	170cm	5'7"
DEADRISE	26°	
TUBE DIAMETER	58cm	23"
NUMBER OF AIR CHAMBERS	6	
MAXIMUM LOAD	1503kg	3312lbs
MAXIMUM PEOPLE	14	
BOAT WEIGHT**	1023kg	2255lbs
MAXIMUM POWER	250hp	
ENGINE SHAFT	XL	
FUEL TANK	285l	
DESIGN CATEGORY	C	

\* boat, console, standard seating, platform & shower kit only

THE SPORT 700 IS A BOAT AT HOME WHEN THE WEATHER GETS UP. THE 26 DEGREE DEADRISE HULL EATS THE CHOP AND KEEPS YOU AND YOUR FAMILY DRY AND SECURE IN ALL CONDITIONS.





# SPORT 760

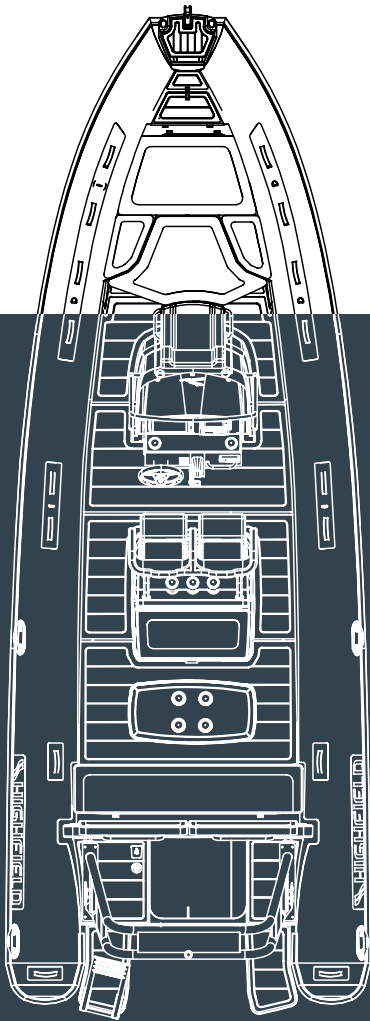

## STANDARD FEATURES

- ORCA® Hypalon or PVC tube
- Welded seams (PVC)
- Flush mount non-return valves
- High tensile chromated & powder coated aluminum hull
- Self-draining deck
- Integrated rear seat with cushion
- Integrated transom supports
- Lifting points and towing eyes
- Brushed foam teak finish deck
- Heavy duty rubbing strake
- Keel guard
- Highfield dry bag
- Foot pump & repair kit
- Electrical pack for boat & console
- Carbon dash for console
- Platform with ladder
- Sundeck
- Roll bar
- Shower kit
- Fridge
- Table

## OPTIONAL EXTRAS

- Bimini

## COLOR SCHEMES



OVERALL LENGTH	760cm	25'
INTERNAL LENGTH	590cm	19' 4"
OVERALL WIDTH	288cm	9' 6"
INTERNAL WIDTH	170cm	5' 7"
DEADRISE	26°	
TUBE DIAMETER	58cm	23"
NUMBER OF AIR CHAMBERS	6	
MAXIMUM LOAD	1753kg	3865lbs
MAXIMUM PEOPLE	16	
BOAT WEIGHT* *	980kg	2161lbs
MAXIMUM POWER	300hp	
ENGINE SHAFT	XL	
FUEL TANK	285l	
DESIGN CATEGORY	C or B	

\* boat, console, standard seating, platform & shower kit only

FLAGSHIP SINGLE ENGINED  
FAMILY RIB WITH HUGE  
OFFSHORE CAPABILITY AND  
AN INCREDIBLY SPACIOUS  
FAMILY FRIENDLY LAYOUT





# SPORT 900

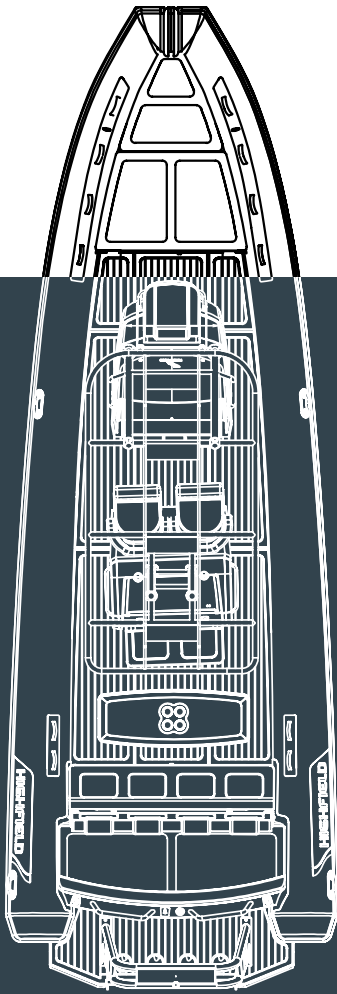

## STANDARD FEATURES

- ORCA® Hypalon or PVC tube
- Welded seams (PVC)
- Flush mount non-return valves
- High tensile chromated & powder coated aluminum hull
- Self-draining deck
- Integrated rear seat with cushion
- Integrated transom supports
- Lifting points and towing eyes
- Brushed foam teak finish deck
- Heavy duty rubbing strake
- Keel guard
- Highfield dry bag
- Foot pump & repair kit
- Electrical pack for boat & console
- Carbon dash for console
- Platform with ladder
- Sundeck
- Shower kit
- Fridge - Table
- AL Console Top

## COLOUR SCHEMES



OVERALL LENGTH	912cm	29'11"
INTERNAL LENGTH	699cm	22'11"
OVERALL WIDTH	310cm	10'2"
INTERNAL WIDTH	184cm	6'
DEADRISE	26°	
TUBE DIAMETER	58cm	23"
NUMBER OF AIR CHAMBERS	6	
MAXIMUM LOAD	2430kg	5357lbs
MAXIMUM PEOPLE	19	
BOAT WEIGHT*	1820kg	4011lbs
MAXIMUM POWER	2 x 300hp	
ENGINE SHAFT	XL	
FUEL TANK	430l	
DESIGN CATEGORY	C	

\* boat, console, standard seating, sundeck & roll bar only

## OPTIONAL EXTRAS

- Stern bimini - FRP top
- Roll bar
- Tow post



OUR LARGEST CRUISING RIB OFFERS MASSIVE INTERNAL SPACE, HUGE DISTANCE CAPABILITY AND THE OPTION FOR UP TO 600HP. A REAL HEADTURNER.





THE

P

atrol range of commercial quality RIBs are designed to work both excellently as a long distance family cruiser or a hardcore work

boat. Built to withstand the toughest of conditions.

The hull is built from 5083 aluminium plates with 6 and 10mm stringers. With their super deep V, wide chines and large diameter tube, they offer high manoeuvrability, high safety and a soft dry ride even in the roughest conditions.

The range offers something for almost every requirement, from Sailing club support to Police and Rescue applications. The Patrol boats carry large loads and plane quickly and easily with little horse-power. For charter boat and commercial operators, the modular set-up option means that we can build a layout that suits your needs. These boats are ideal pursuit craft or work boats and can be configured with different seating and console options. When safety, toughness & reliability really matter, the Patrol range should be your first port of call.

With MCA rating & commercial coding available, the Patrol range is perfect for commercial chartering or working offshore too.



# PATROL 420 & 460

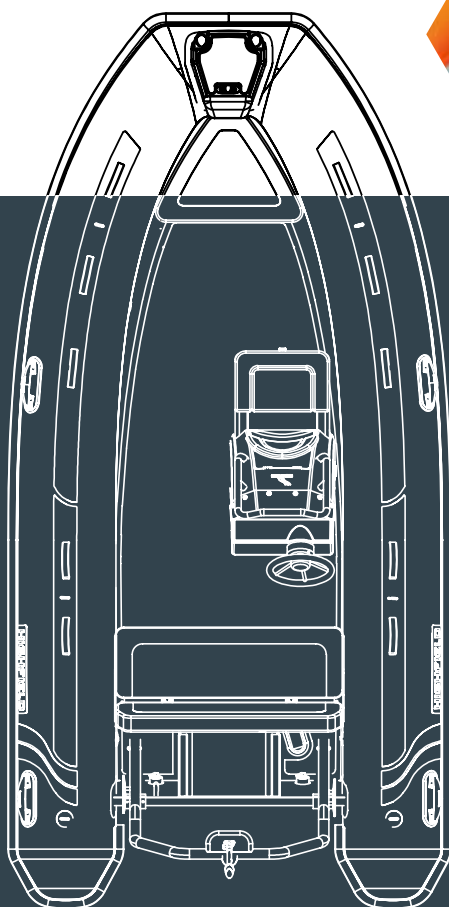

## STANDARD FEATURES

- ORCA® Hypalon or PVC tube
- Welded seams (PVC)
- Flush mount non-return valves
- High tensile chromated & powder coated aluminum hull
- Integrated transom supports
- Self-draining deck
- Integrated under-deck fuel tank
- Lifting points and towing eyes
- Tow bridle points
- Anti-slip deck
- Heavy duty rubbing strake
- Keel guard
- Highfield dry bag
- Foot pump, oars, repair kit
- Carbon dash
- Electrical pack for console
- Electrical pack for boat

## OPTIONAL EXTRAS

- Console & seat options
- Rear tow post - Roll Bar
- Transom ladder
- Brushed foam teak finish deck
- Bow cushion

## COLOUR SCHEMES



	PA420		PA460	
<b>OVERALL LENGTH</b>	421cm	13'10"	459cm	15'1"
<b>INTERNAL LENGTH</b>	317cm	10'5"	353cm	11'7"
<b>OVERALL WIDTH</b>	210cm	6'11"	211cm	6'11"
<b>INTERNAL WIDTH</b>	105cm	3'5"	105cm	3'5"
<b>DEADRISE</b>	20°		20°	
<b>TUBE DIAMETER</b>	47cm	19"	47cm	19"
<b>NUMBER OF AIR CHAMBERS</b>	4		5	
<b>MAXIMUM LOAD</b>	823kg	1814lbs	944kg	2081lbs
<b>MAXIMUM PEOPLE</b>	8		9	
<b>BOAT WEIGHT*</b>	252kg	556lbs	286kg	631lbs
<b>MAXIMUM POWER</b>	60hp		80hp	
<b>ENGINE SHAFT</b>	L		L	
<b>FUEL TANK (LITRES)</b>	40l		40l	

\* boat, console & roll-bar only

THE PERFECT SMALL WORKBOAT, BUILT TO BE STRONG & AGILE. THE IDEAL CHOICE FOR SAILING CLUBS, HARBOURS OR EVEN AS SMALL RESCUE BOATS





# PATROL 500

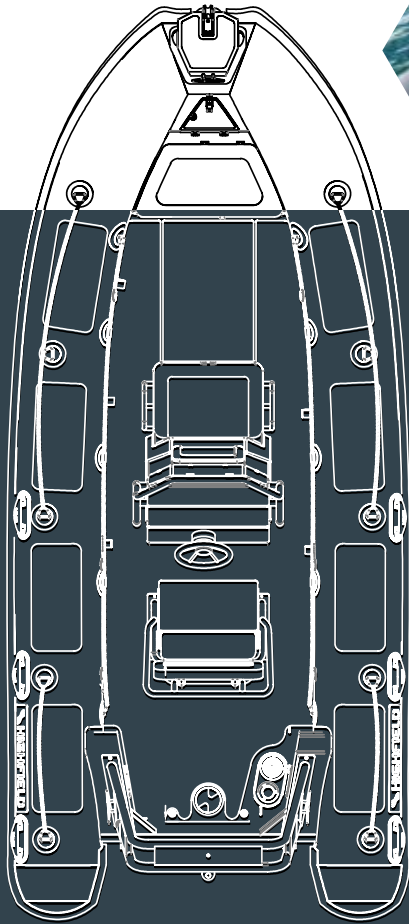

## STANDARD FEATURES

- ORCA® Hypalon or PVC tube
- Welded seams (PVC)
- Flush mount non-return valves
- High tensile chromated & powder coated aluminum hull
- Integrated transom supports
- Self-draining deck
- Integrated under-deck fuel tank (40L)
- Lifting points and towing eyes
- Tow bridle points
- Anti-slip deck
- Heavy duty rubbing strake
- Keel guard
- Highfield dry bag
- Foot pump, oars, repair kit
- Carbon dash
- Bow cushion
- Electrical pack for console
- Electrical pack for boat

## OPTIONAL EXTRAS

- Console & seat options
- Rollbar - Rear tow post
- Transom ladder
- Brushed foam teak finish deck
- Dive rack

## COLOUR SCHEMES



OVERALL LENGTH	500cm	16'5"
INTERNAL LENGTH	416cm	13'8"
OVERALL WIDTH	228cm	7'6"
INTERNAL WIDTH	120cm	3'11"
DEADRISE	24°	
TUBE DIAMETER	52cm	20"
NUMBER OF AIR CHAMBERS	6	
MAXIMUM LOAD	1051kg	2317lbs
MAXIMUM PEOPLE	10	
BOAT WEIGHT*	441kg	972lbs
MAXIMUM POWER	100hp	
ENGINE SHAFT	XL	
FUEL TANK	90l	
DESIGN CATEGORY	C	

\* boat, console, standard seating & roll-bar only

A LARGER CONSOLE & A CHOICE BETWEEN BOLSTER OR JOCKEY SEATS. 100HP OF POWER MAKES THIS THE PERFECT SMALL WORKHORSE.





# PATROL 540

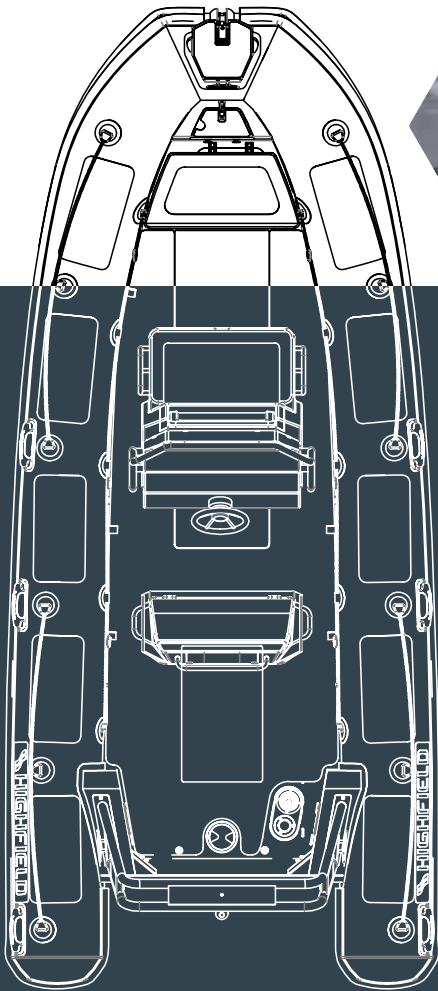

## STANDARD FEATURES

- ORCA® Hypalon or PVC tube
- Welded seams (PVC)
- Flush mount non-return valves
- High tensile chromated & powder coated aluminum hull
- Integrated transom supports
- Self-draining deck
- Integrated under-deck fuel tank
- Lifting points and towing eyes
- Tow bridle points
- Anti-slip deck
- Heavy duty rubbing strake
- Keel guard
- Highfield dry bag
- Foot pump, oars, repair kit
- Carbon dash
- Bow cushion
- Electrical pack for console
- Electrical pack for boat

## OPTIONAL EXTRAS

- Console & seat options
- Rollbar - T-Top - Dive rack
- Transom ladder
- Brushed foam teak finish deck

## COLOUR SCHEMES



<b>OVERALL LENGTH</b>	540cm	17'9"
<b>INTERNAL LENGTH</b>	430cm	14'1"
<b>OVERALL WIDTH</b>	248cm	8'2"
<b>INTERNAL WIDTH</b>	133cm	4'4"
<b>DEADRISE</b>	24°	
<b>TUBE DIAMETER</b>	52cm	20"
<b>NUMBER OF AIR CHAMBERS</b>	6	
<b>MAXIMUM LOAD</b>	1262kg	2782lbs
<b>MAXIMUM PEOPLE</b>	12	
<b>BOAT WEIGHT*</b>	494kg	1089lbs
<b>MAXIMUM POWER</b>	115hp	
<b>ENGINE SHAFT</b>	XL	
<b>FUEL TANK</b>	105l	
<b>DESIGN CATEGORY</b>	C	

\* boat, console, standard seating & roll-bar only



AN INCREDIBLY CAPABLE RIB, IDEAL FOR BOTH FAMILY DISTANCE CRUISING OR COMMERCIAL USE INCLUDING TEACHING, CHARTER AND HARBOUR WORK. THE PATROL 600 REALLY IS A PERFECT ALL-ROUNDER - QUICK, DRY AND ECONOMICAL.





# PATROL 600

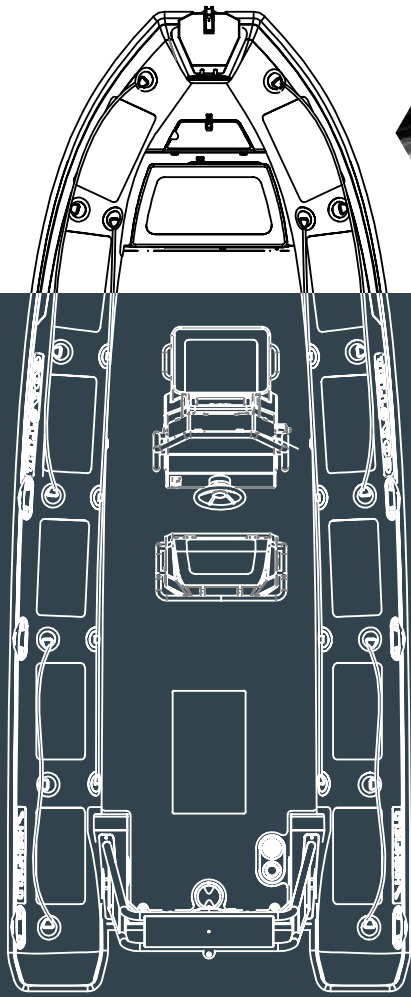

## STANDARD FEATURES

- ORCA® Hypalon or PVC tube
- Welded seams (PVC)
- Flush mount non-return valves
- High tensile chromated & powder coated aluminum hull
- Integrated transom supports
- Self-draining deck
- Integrated under-deck fuel tank
- Lifting points and towing eyes
- Tow bridle points
- Anti-slip deck
- Heavy duty rubbing strake
- Keel guard
- Highfield dry bag
- Foot pump, oars, repair kit
- Carbon dash
- Bow cushion
- Electrical pack for console
- Electrical pack for boat

## OPTIONAL EXTRAS

- Console & seat options
- Rollbar - T-Top - Dive rack
- Transom ladder - Roll bar with ladder
- Brushed foam teak finish deck

## COLOR SCHEMES



OVERALL LENGTH	616cm	20'3"
INTERNAL LENGTH	437cm	14'4"
OVERALL WIDTH	249cm	8'2"
INTERNAL WIDTH	132cm	4'4"
DEADRISE	26°	
TUBE DIAMETER *	56cm	22"
NUMBER OF AIR CHAMBERS	6	
MAXIMUM LOAD	1458kg	3214lbs
MAXIMUM PEOPLE	14	
BOAT WEIGHT **	694kg	1530lbs
MAXIMUM POWER	150hp	
ENGINE SHAFT	XL	
FUEL TANK	140l	
DESIGN CATEGORY	C	

\*smaller tube diameter available \*\* boat, console, roll-bar & standard seating only



AN INCREDIBLY CAPABLE RIB, IDEAL FOR BOTH FAMILY DISTANCE CRUISING OR COMMERCIAL USE INCLUDING TEACHING, CHARTER AND HARBOUR WORK. THE PATROL 600 REALLY IS A PERFECT ALL-ROUNDER - QUICK, DRY AND ECONOMICAL.



# PATROL 660

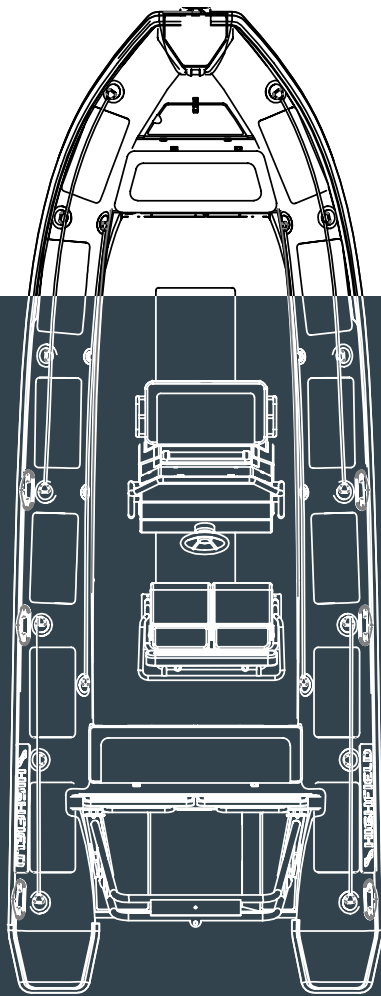

## STANDARD FEATURES

- ORCA® Hypalon or PVC tube
- Welded seams (PVC)
- Flush mount non-return valves
- High tensile chromated & powder coated aluminum hull
- Integrated transom supports
- Self-draining deck
- Integrated under-deck fuel tank
- Lifting points and towing eyes
- Tow bridle points
- Anti-slip deck
- Heavy duty rubbing strake
- Keel guard
- Highfield dry bag
- Foot pump, oars, repair kit
- Carbon dash
- Bow cushion
- Electrical pack for console
- Electrical pack for boat

## OPTIONAL EXTRAS

- Console & seat options
- Rollbar - T-Top - Dive rack
- Transom ladder - Roll bar with ladder
- Brushed foam teak finish deck

## COLOUR SCHEMES



OVERALL LENGTH	651cm	21'4"
INTERNAL LENGTH	475cm	15'7"
OVERALL WIDTH	259cm	8'6"
INTERNAL WIDTH	135cm	4'5"
DEADRISE	26°	
TUBE DIAMETER	58cm	23"
NUMBER OF AIR CHAMBERS	6	
MAXIMUM LOAD	1287kg	2837lbs
MAXIMUM PEOPLE	13	
BOAT WEIGHT*	740kg	1631lbs
MAXIMUM POWER	200hp	
ENGINE SHAFT	XL	
FUEL TANK	140l	
DESIGN CATEGORY	C	

\* boat, console, roll-bar & standard seating only



AN OPTIONAL T-TOP ALLOWS THE PATROL MODELS TO BECOME EVEN MORE PRACTICAL BY OFFERING MORE SHELTER AND GREATER PROTECTION FROM THE ELEMENTS, CREATING A TRULY VERSATILE ALL-WEATHER RIB.



# PATROL 700

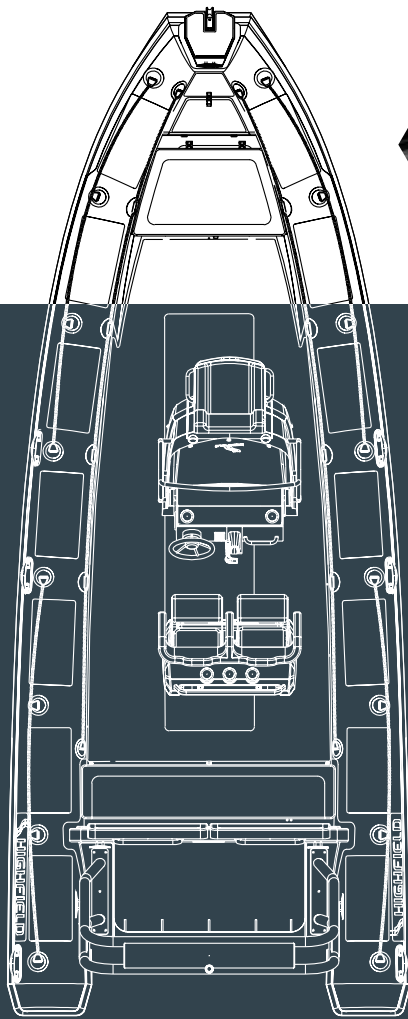

## STANDARD FEATURES

- ORCA® Hypalon or PVC tube
- Welded seams (PVC)
- Flush mount non-return valves
- High tensile chromated & powder coated aluminum hull
- Integrated transom supports
- Self-draining deck
- Integrated under-deck fuel tank
- Lifting points and towing eyes
- Tow bridle points
- Anti-slip deck
- Heavy duty rubbing strake
- Keel guard
- Highfield dry bag
- Foot pump, oars, repair kit
- Carbon dash
- Bow cushion
- Electrical pack for console
- Electrical pack for boat

## OPTIONAL EXTRAS

- Console & seat options
- Rollbar - T-Top - Dive rack
- Roll bar with ladder - Transom ladder
- Brushed foam teak finish deck

## COLOUR SCHEMES



OVERALL LENGTH	719cm	23'7"
INTERNAL LENGTH	538cm	17'8"
OVERALL WIDTH	293cm	9'7"
INTERNAL WIDTH	169cm	5'7"
DEADRISE	26°	
TUBE DIAMETER	58cm	23"
NUMBER OF AIR CHAMBERS	6	
MAXIMUM LOAD	1503kg	3312lbs
MAXIMUM PEOPLE	14	
BOAT WEIGHT**	1023kg	2255lbs
MAXIMUM POWER	250hp	
ENGINE SHAFT	XL	
FUEL TANK	285l	
DESIGN CATEGORY	C	

\* boat, console, standard seating, platform & shower kit only



OUR MID-SIZED WORKHORSE. LONG RANGE FUEL TANK, MODULAR LAYOUT & WIDE BEAM MAKE THE PA700 A GREAT VALUE, CAPABLE ALLROUNDER.



# PATROL 760

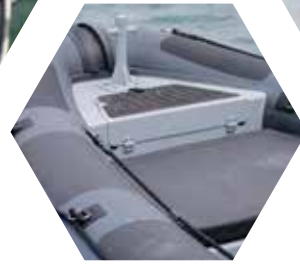
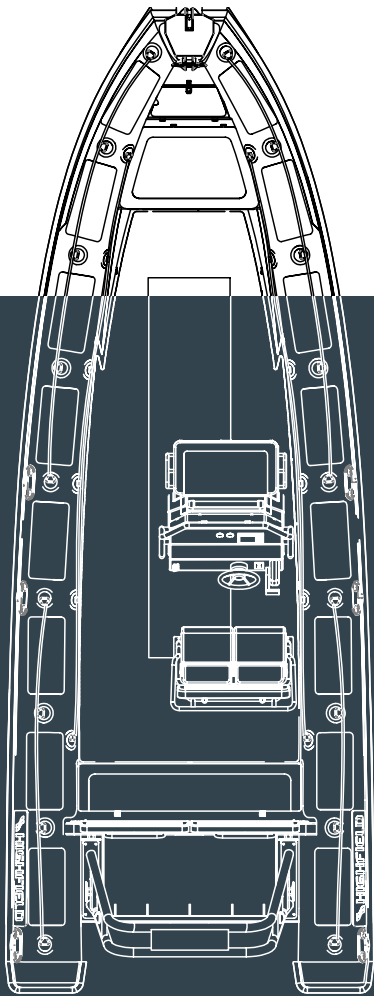

## STANDARD FEATURES

- ORCA® Hypalon or PVC tube
- Welded seams (PVC)
- Flush mount non-return valves
- High tensile chromated & powder coated aluminum hull
- Integrated transom supports
- Self-draining deck
- Integrated under-deck fuel tank
- Lifting points and towing eyes
- Tow bridle points
- Anti-slip deck
- Heavy duty rubbing strake
- Keel guard
- Highfield dry bag
- Foot pump, oars, repair kit
- Carbon dash
- Bow cushion
- Electrical pack for console
- Electrical pack for boat

## OPTIONAL EXTRAS

- Console & seat options
- Rollbar - Dive rack
- T-Top / XL T-Top
- Brushed foam teak finish deck
- Roll bar with ladder - Transom ladder

## COLOUR SCHEMES



<b>OVERALL LENGTH</b>	760cm	25'
<b>INTERNAL LENGTH</b>	590cm	19'4"
<b>OVERALL WIDTH</b>	288cm	9'6"
<b>INTERNAL WIDTH</b>	169cm	5'7"
<b>DEADRISE</b>	26°	
<b>TUBE DIAMETER</b>	58cm	23"
<b>NUMBER OF AIR CHAMBERS</b>	6	
<b>MAXIMUM LOAD</b>	1753kg	3865lbs
<b>MAXIMUM PEOPLE</b>	16	
<b>BOAT WEIGHT*</b>	980kg	2161lbs
<b>MAXIMUM POWER</b>	300hp	
<b>ENGINE SHAFT</b>	XL	
<b>FUEL TANK</b>	285l	
<b>DESIGN CATEGORY</b>	C or B	

\* boat, console, standard seating, & roll-bar kit only



POWERFUL, LONG-RANGE CRUISER  
ABLE TO COPE WITH THE MOST  
CHALLENGING CONDITIONS. MODULAR  
DESIGN FOR ANY SITUATION.



# PATROL 860

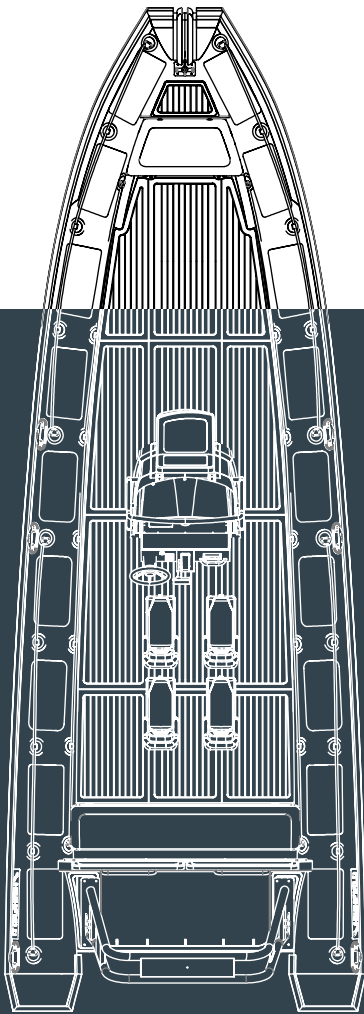

## STANDARD FEATURES

- ORCA® Hypalon or PVC tube
- Welded seams (PVC)
- Flush mount non-return valves
- High tensile chromated & powder coated aluminum hull
- Integrated transom supports
- Self-draining deck
- Integrated under-deck fuel tank
- Lifting points and towing eyes
- Tow bridle points
- Anti-slip deck
- Heavy duty rubbing strake
- Keel guard
- Highfield dry bag
- Foot pump, oars, repair kit
- Carbon dash
- Bow cushion
- Electrical pack for console
- Electrical pack for boat

## OPTIONAL EXTRAS

- Console & seat options
- Rollbar - Roll bar with ladder
- T-Top / XL T-Top
- Brushed foam teak finish deck
- Dive rack

## COLOUR SCHEMES



OVERALL LENGTH	860cm	28'3"
INTERNAL LENGTH	631cm	20'8"
OVERALL WIDTH	310cm	10'2"
INTERNAL WIDTH	184cm	6'
DEADRISE	26°	
TUBE DIAMETER	58cm	23"
NUMBER OF AIR CHAMBERS	6	
MAXIMUM LOAD	2106kg	4643lbs
MAXIMUM PEOPLE	20	
BOAT WEIGHT*	1392kg	3069lbs
MAXIMUM POWER	2 x 300hp	
ENGINE SHAFT	XL / UL	
FUEL TANK	430l	
DESIGN CATEGORY	C or B	

\* boat, console, standard seating, & roll-bar kit only



LONG RANGE TANKS AND A MODULAR DESIGN ALLOW THE PA860 TO BE BUILT FOR PERFORMANCE, FAMILY BOATING OR A NUMBER OF COMMERCIAL REQUIREMENTS.



# OUR NEW 2023 COLOUR SCHEMES

Whether you like a pop of colour or prefer something a little more subtle, our 2023 colour schemes ensure there is a look for you.

## ULTRALITE

VL220 & VL240



BL DG LG WH

VL260 & VL290



BL DG LG WH

VL310 & VL340



BL DG LG WH

## CLASSIC

CL260 & CL290



BL DG LG WH

CL310 & CL340



BL DG LG WH

CL360 & CL380



BL DG LG WH

CL340-380 4T CONSOLE



BL DG LG WH

CL340-380 FCT CONSOLE



BL DG LG WH

CL420 & CL460



BL DG LG WH



# PATROL

PA420 & PA460



BL DG LG ORG RED

PA500 & PA540



BL DG LG ORG RED

PA600 & PA660



BL DG LG ORG RED

PA700



BL DG LG ORG RED

PA760



BL DG LG ORG RED

PA860



BL DG LG ORG RED

# SPORT

SP300-360



BL BGS DGS IVORY LG WH

SP390 & SP420 & SP460



BL BGS DGS IVORY LG WH

SP520



BL BGS DGS IVORY LG WH

SP560



BB BGS DGS EB LG WH

SP600, SP660 & SP700



BB DGG DGS BC LG

SP760



BB DGG DGS BC LG

SP900



WB BC LG





**HIGHFIELD**  
dare to explore



**Terms & Conditions:** These specification details do not apply to any particular product which is supplied or offered for sale. The manufacturer reserve the right to vary their specification, including colours, with or without notice at such times in such manner as they think fit. Major as well as minor changes may be involved. Every effort, however, is made to ensure the accuracy of the particulars contained in this brochure. Consult the Dealer with whom your order is placed for details of the specification of any particular product. This publication shall not constitute in any circumstances whatsoever an offer by the Company to any person. All sales are made by the Distributor or Dealer concerned subject to and with the benefit of the standard Conditions of Sale and Warranty given by the Distributor or Dealer, copies of which may be obtained from him on request.