

POLARIS

2021

ACCESSORIES + APPAREL



CONTENTS

YOUTH 4

RANGER 150	4
ACE 150	5
RZR 170	5
YOUTH TIRES	6

2021 NORTHSTAR EDITIONS 9

RANGER 26

XP 1000, 1000 & DIESEL 24

3-SEAT & CREW	24
ROOFS	26
WINDSHIELDS	28
REAR PANELS	30
DOORS	32
CAB COMFORT & CONVENIENCE	34
ELECTRICAL ACCESSORIES	36
WINCHES	38
PROTECTION	40
TECHNOLOGY	44
STORAGE	48

COMMON ACCESSORIES 52

HUNT	52
COLD WEATHER	55
PLOWS	56
LIGHTING	60

570 FULL SIZE 3-SEAT & CREW 62

TIRES	64
-------	----

570/500 MID SIZE 2-SEAT & CREW 65

ROOFS	66
DOORS	67
WINDSHIELDS & REAR PANELS	68
CONVENIENCE & PROTECTION	70
WINCHES	71
STORAGE	74
TIRES	76
LIGHTING	77

PRO XD 78

ACCESSORIES SELL SHEETS	80
CAB ADVANTAGE	81

GENERAL 82

WINDSHIELDS + REAR PANELS	88
DOORS	90
ROOFS	92
VEHICLE & RIDER PROTECTION	93
STORAGE	94
CAB COMFORT	96
HUNT	98
RIDE COMMAND & AUDIO	100
LIGHTING	102
WINCHES	104
PLOWS & TRACKS	105
WHEELS & TIRES	106

RZR 108

PRO XP 112

AUDIO	117
WINDSHIELDS & REAR PANELS	119
ROOFS	120
DOORS & HEATERS	121
VEHICLE PROTECTION	122
LIGHTING	123
STORAGE	124
MISC, MIRRORS	126
WINCHES	127
AFTERMARKET	128

TURBO S & XP 130

WINDSHIELDS	132
REAR PANELS	133
ROOFS	134
DOORS	135
VEHICLE PROTECTION	135
WINCHES	137
STORAGE & MIRRORS	138

RZR RS1 140

TRAIL 142

WINDSHIELDS & REAR PANELS	144
ROOFS	146
DOORS	147
BUMPERS & ROCK SLIDERS	148
STORAGE & WINCHES	150
LIGHTING	152
RIDECOMMAND	158
AUDIO SYSTEM	160
VEHICLE & RIDER PROTECTION	164
COCKPIT ACCESSORIES	166
MIRRORS	167
WINCHES	168
TIRES & PARTICLE SEPARATORS	170
570	173

COMMON ACCESSORIES 174

WHEELS & TIRES	176
ADDITIONAL ACCESSORIES	188
COOLERS	190
MAINTENANCE SCHEDULE	192
OILS & PARTS	194
BATTERY CHARGER	198
SHOP ACCESSORIES	199
TRAILERING	200
HITCHES, SNAPS & ROPES	201
OUTERWEAR & PROTECTION	204
HELMETS	204
APPAREL	212
GIFTS & BRANDED MERCHANDISE	221
PROMOTIONAL ITEMS	222

ACCESSORIES

> YOUTH



POLARIS ACE 150 EFI



RZR 170



RANGER 150

> RANGER 150



FULL-WINDSHIELD - POLY

- .32 cm clear poly carbonate
- Mounts with 4 simple p-clamps

» 2883288
150 '19-21



HALF-WINDSHIELD - POLY

- 33 cm tall
- .32 cm clear poly carbonate
- Mounts with 4 simple p-clamps

» 2883298
150 '19-21



SPORT ROOF - POLY

- Shields you from rain, snow, sun
- Easy install

» BLACK • 2883289
150 '19-21

SEAT COVER

» P818Q
150 '19-21



FRONT & REAR BRUSHGUARD - SET

- Includes front and rear bumper
- Durable, E-coated steel construction

» BLACK • 2883287
150 '19-21



SAFETY DOORS - STEEL

» AUST545
» 150 '19-21

> RZR 170



HALF WINDSHIELD

- Provides protection from rain, debris and branches
- Installs easily and securely
- Retains open-air riding environment
- Adds sporty style

» 2877684
170 '14, '16-21



FRONT BRUSHGUARD

- Strong, tough, and protective
- Styling and finish complement vehicle's look
- Protects front end of vehicle from impact
- Easy bolt-on installation

» 2877813
170 '14, '16-21



SOFT TOP

- Adds sporty styling and offers protection
- Provides shade for riders
- Protects against rain, overhead branches, etc.
- Easy installation

» 2877685
170 '14, '16-21

> ACE 150

**THE ONLY SINGLE SEAT
YOUTH ATV WITH A
FULL CAB FRAME**



SAFETY DOORS STEEL

» AUST553
POLARIS ACE 150 '18-21

POLY ROOF

» 2882263
POLARIS ACE 150 '17-21

HALF POLY WINDSHIELD

» 2882264
POLARIS ACE 150 '17-21

FRONT & REAR BUMPER SET

» 2882472
POLARIS ACE 150 '17-21

SEAT COVER

» P818Q
ACE 150 '17-21

TIRES



YOUTH

NEW

YOUTH CRAWLER TIRE

- Upgraded youth tire for added durability
- Increased ground clearance and performance

RANGER 150 '19-21

		TREAD DEPTH	TIRE WEIGHT	PLY RATING	SIDEWALL BELTS	LOAD RATING
12"	22" x 8" R12 5416945	13mm	13 kg	6	3	413 kg
12"	22" x 10" R12 5416944					

NEW

YOUTH BUCKLE - BLACK

- » FRONT • 12" x 7" • 1524114
- » REAR • 12" x 8" • 1524115

RANGER 150 '19-21

NEW

PRO ARMOR WHEEL & TIRE KIT: YOUTH CRAWLER & BUCKLE

- » 2885154

RANGER 150 '19-21



WHEEL SIZE

12"

POLARIS *RANGER*

2021

ACCESSORIES + APPAREL

FULL SIZE



HARDEST WORKING. SMOOTHEST RIDING.



For the past two decades, RANGER has set the standard through unrivaled strength, unmatched capability and next-level comfort, making it the number one utility side-by-side for over 10-years running.



CONTENTS

2021 NORTHSTAR EDITIONS **9**

RANGER FULL SIZE **26**

XP 1000, 1000 & DIESEL **24**

3-SEAT & CREW **24**

ROOFS 26

WINDSHIELDS 28

REAR PANELS 30

DOORS 32

CAB COMFORT & CONVENIENCE 34

ELECTRICAL ACCESSORIES 36

WINCHES 38

PROTECTION 40

TECHNOLOGY 44

STORAGE 48

COMMON ACCESSORIES **52**

HUNT 52

COLD WEATHER 55

PLOWS 56

LIGHTING 60

570 FULL SIZE 3-SEAT & CREW **62**

TIRES 64

570/500 MID SIZE 2-SEAT & CREW **65**

ROOFS 66

DOORS 67

WINDSHIELDS & REAR PANELS 68

CONVENIENCE & PROTECTION 70

WINCHES 71

STORAGE 74

TIRES 76

LIGHTING 77

RANGER XP 1000 NORTHSTAR OFF-ROAD CLIMATE CONTROL

Be in control of your comfort with standard Pro Shield cab system, heat, air conditioning, and more. Polaris RANGER XP 1000 NorthStar helps you finish whatever task you set out to do, no matter the weather conditions. Take your NorthStar to the next level with hundreds of accessories to choose based on your riding needs.



DO MORE:

PROTECTION

Protect the front and rear of your RANGER from whatever obstacles you may encounter off-road.
P. 32

AUDIO

Customize your audio system to listen to your favorite songs on the trails.
P. 34

LIGHTING

Extend the day and work longer with easy-to-install powerful lighting.
P. 52

STORAGE

Leave nothing behind with the limitless customization of Lock & Ride storage.
P. 38

WHEELS & TIRES

Select wheels and tires custom built for your riding style and the terrain you ride in.
P. 54

UPGRADE YOUR NORTHSTAR

RANGER XP 1000 FAMILY

You've got the essentials straight from the factory—but why stop there? Get the most out of your NorthStar with additional Polaris Engineered accessories to fit your riding needs. Add the **MUST HAVES** for top-selling accessories or **UTILITY** to optimize for the toughest outdoor jobs. Or, pick and choose your favorite accessories to make it your own.



NORTHSTAR PREMIUM COMES STANDARD WITH:

- Heating & Air Conditioning HVAC System
- Polaris Pro 4,500 lb. Winch
- Sport Roof with Premium Liner & Dome Light
- Lock & Ride Glass Windshield with Wiper/Washer System
- Lock & Ride Glass Rear Panel
- Premium Manual Crank Window Doors

	PART NUMBER	PRODUCT NAME	PAGE NUMBER
MUST HAVES	2882531	Upper Front Brushguard	P. 40
	2882529	Rear Brushguard	P. 40
	2882690	Front Hood Storage Rack	P. 48
	2883279	Lock & Ride Storage Box	P. 51
	2883230	Polaris PULSE Wiring Harness - 1 Light Bar	P. 37
	2882077	Pro Armor 84cm - Combo LED Light Bar	P. 61
UTILITY	2883265	Work Beacon LED Light	P. 35
	2883230	Polaris PULSE Wiring Harness - 1 Light Bar	P. 37
	2882752	Lock & Ride Bed Extender/Divider	P. 48
	2884141	Electronic Cargo Box Lift	P. 50
	2882384	Pro Armor Wheel & Tire Set: Buckle & Harvester, 27R14	P. 60

TAKE ADVANTAGE of your off-road climate control with winter and plow accessories on P. 190



TAKE YOUR 2021 RANGER NORTHSTAR TO THE NEXT LEVEL



Customize your experience by adding key accessories.

WINTER

RANGER 1000

MOST POPULAR ADD-ONS

RANGER PRO SHIELD CAB SYSTEM	P. 10
PROTECTION	P. 40
COLD WEATHER	P. 55
LIGHTING	P. 60
WHEELS & TIRES	P. 180



RIDE COMMAND

RANGER XP 1000

MOST POPULAR ADD-ONS

RANGER PRO SHIELD CAB SYSTEM	P. 10
STORAGE	P. 48
COLD WEATHER	P. 55
LIGHTING	P. 60



RIDECMD

POLARIS

ENGINEERED

DESIGNED



Designed by the same people who designed your vehicle.

TESTED



Extensively tested in the field so you ride with 100% confidence.

WE HOLD OUR PARTNERS TO THE SAME STANDARDS

PRO ARMOR

WHEELS, TIRES & LIGHTING DESIGNED WITH POLARIS TO MAXIMIZE PERFORMANCE
P. 52 LIGHTING, P. 54 TIRES & WHEELS

KEEP YOUR STANDARDS HIGH. WE DO.

TRUSTED



65 years in the business.
The #1 name in Off-Road.

MBQUART®

IGNITE AND FUEL YOUR PASSION FOR PRECISE
QUALITY SOUND REPRODUCTION

P. 45

RIGID®

PRODUCTS SO GOOD THEY REPLACE
OR REPAIR THEM FOR LIFE

P. 60

KOLPIN® OUTDOORS

MAKING PRODUCTS FOR AVID
SPORTSMEN SINCE 1943

P. 52

RANGER XP 1000, 1000 & DIESEL



INDUSTRY-LEADING ACCESSORIES
ENGINEERED TO DO MORE
FOR EVERY KIND OF JOB BIG OR SMALL

INDUSTRY-LEADING COMFORT

LEVERAGE THE FULL CAPABILITIES OF YOUR MACHINE YEAR-ROUND.



SUPERIOR INTEGRATION

MAKE WORK EASIER WITH YOUR VEHICLE BUILT TO ADD ESSENTIAL ACCESSORIES FOR ANY JOB.

PRO PRO HEAVY DUTY SERIES

WINCHES

GLACIER
PLOW SYSTEM

POLARIS
PULSE
Electrical System



DO MORE

TACKLE ANY JOB AND LEAVE NOTHING BEHIND.

LOCK & RIDE

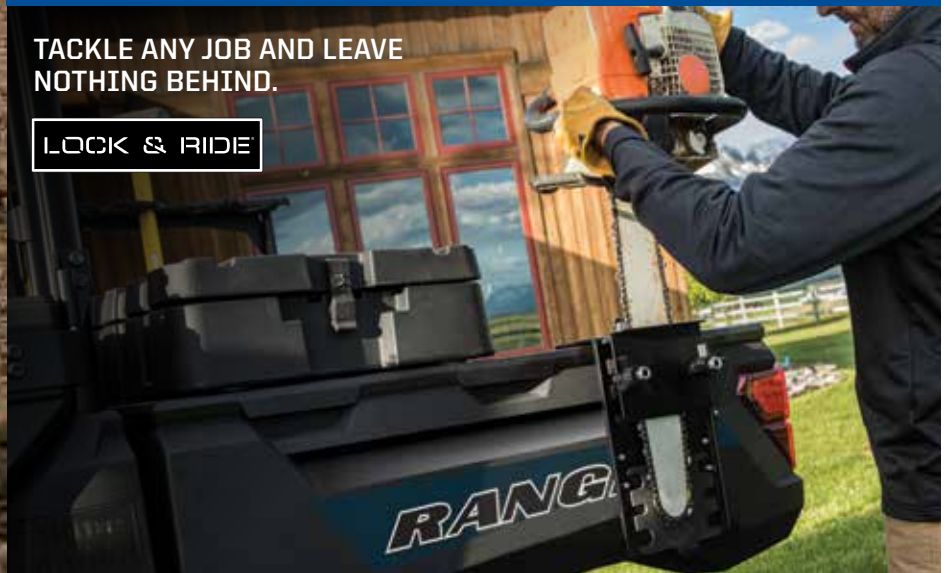

ENGINEERED FOR

HARDEST WORKING, SMOOTHEST RIDING. RANGER is the world's most trusted, most capable, work partner in the world. Developed and tested along with the vehicle, Polaris Engineered Accessories are designed for seamless integration and simple installation to get more done, year-round.

SUPERIOR INTEGRATION

PRO PRO HEAVY DUTY SERIES

WINCHES

P. 38

INTEGRATED WINCH MOUNT & PRE-WIRED

Designated mounting points and pre-wired contactors ensure a perfect fit and the strongest place to attach the Polaris Engineered winch - the most dependable winch for your RANGER. With wiring built right into the vehicle, we made this the easiest RANGER winch ever made to install.

GLACIER

P. 56

PLOW SYSTEM

INTEGRATED PLOW MOUNT

The attachment points for the best-in-class Glacier Plow System are integrated right at the factory and feature an innovative drive-up and go installation process.

POLARIS PULSE™
Electrical System

P. 36

PLUG & PLAY ELECTRICAL

A revolution in electrical accessory integration, the Polaris PULSE Electrical System allows for a simple Plug & Play approach for adding power to Polaris Engineered Accessories.



MORE

POLARIS
ENGINEERED



DO MORE

LOCK & RIDE

P. 48

CARGO BOX VERSATILITY

Lock & Ride mounting locations allow for limitless customization to let you work the way you want.

INDUSTRY-LEADING COMFORT

OUR BEST SEALING CAB

With the profile channels engineered into the roll cage, body plastics molded to seal and cab accessories designed to keep the elements out, the RANGER Pro Shield Cab System offers a new level of interior comfort.



P. 11



INDUSTRY-LEADING COMFORT

Look for the RANGER PRO SHIELD Logo for the 4 components to customize your RANGER with our best sealing cab.



ULTIMATE CLARITY

Tempered safety glass, clear to see through and shatterproof.

COLOR MATCHED

Key color matched accent panels available for all XP 1000 & 1000 models.

PROTECTION

Inner & outer shells are made from high-quality, injection-molded plastics using a state-of-the-art process to shield from the elements and more.

EASY-ON/OFF HINGES

Once installed, the pin system allows for easy on & off.

DURABLE CONSTRUCTION

With a 2.5 cm tube steel frame these doors can handle the rigors of the off-road.



1 CHOOSE YOUR ROOF
P. 26

2 CHOOSE YOUR WINDSHIELD
P. 28

3 CHOOSE YOUR REAR PANEL
P. 30

4 CHOOSE YOUR DOORS
P. 32

NEXT-LEVEL INTERIOR COMFORT

Add a new level of interior comfort by adding a RANGER Pro Shield Cab System - tested to military standards. Seal out dust, water, and noise by selecting a roof, windshield, rear panel, and set of doors. Extend your work day or trail ride while protecting you and your passengers from the elements.



RAIN

Rest assured that you and your passengers will stay dry and comfortable on rainy days

A FRAME DESIGNED FOR A CAB

All RANGER cab components fit perfectly to the contours of the RANGER XP 1000 and RANGER 1000 profile tube cab frame, floor and body panels, allowing for a 360° gasket seal, seamless fit and installation providing unprecedented protection from the elements.



AVAILABLE FOR
**RANGER XP 1000,
RANGER 1000 & DIESEL**



SNOW

Keep cold wind and snow out in winter months



DUST

Reduce dust swirl in the cab of your RANGER for increased comfort and visibility

SUPERIOR

INTEGRATION

PRO PRO HEAVY DUTY SERIES



WINCHES P. 38

H-D HEAVY DUTY SERIES



POLARIS ENGINEERED WINCH FEATURES



Tested **1,200+** pulls
at max load, it works
when you need it to



Built to withstand
-29° C temperatures



Sealed motor & heavy
duty gears **OPERATE
FULLY SUBMERGED
UNDERWATER**



MILITARY
tested & approved



Right from the factory, your vehicle is built to make essential accessories like winches and plows easy to use day-in and day-out. Mounting brackets are designed into the oversized factory bumper and wiring is routed securely and properly. When it comes to RANGER, Polaris Engineered Accessories make work easier so you can get more done.

PRE-WIRED CHASSIS

Dash mounted controls and wiring are installed at the factory. Mount the winch, connect the wires and trust that everything is routed safely, securely, and properly.

NO NEED TO CUT PANELS





FULLY INTEGRATED MOUNT & WIRING

GLACIER

PLOW SYSTEM



GLACIER FEATURES

-  To install the plow, simply lift the mount lock handle and pull forward
-  No loss of factory ground clearance when not plowing
-  Don't have to crawl under the machine to release the plow blade from the vehicle
-  No trimming of vehicle plastic or fascia required to mount plow or winch

ANGLE YOUR BLADE
RIGHT FROM YOUR SEAT

25°

LEFT AND RIGHT



MAKE IT YOURS.

WORK HARD AND GET IT DONE with Polaris Engineered Accessories for your RANGER. Start with the ultimate in all-season performance and comfort with the best cab components in the industry. Find everything you need to outfit your RANGER for the task at hand.



RANGER XP 1000 / RANGER 1000 & DIESEL

WORK

2883265	Work Beacon LED Light	P. 35
2882752	LOOK & RIDE Bed Extender/Divider	P. 48
2882910	Dual Bin Under Seat Dry Storage Box	P. 34
2882753	8-Vent Heater & Defrost System	P. 34
2883121	Rigid SR-Series 25 cm Spot LED Light	P. 60
2882710	Polaris PRO HD 2,722 kg Winch with Rapid Rope Recovery	P. 39
2882531	Upper Front Brushguard	P. 40
2881531	LOOK & RIDE Tip-Down Headache Rack	P. 48
2882529	Rear Brushguard	P. 40
2883148	Pro Armor Wheel & Tire Set: Dual Threat & Buckle - Accent	P. 183



RANGER XP 1000

HUNT

2883265	Work Beacon LED Light	P. 35
2883263	In-Cab Gun Mount	P. 53
2884271	Pro Armor Wheel & Tire Set: Mud XC & Shackle - Matte Black	P. 183
2882076	Pro Armor 5x5 cm Cube - LED Spot Light (x2)	P. 60
2882711	Polaris PRO HD 2,041 kg Winch with Rapid Rope Recovery	P. 39
2882690	Front Hood Storage Rack	P. 48
2882177	LOOK & RIDE CargoMax System	P. 48



RANGER XP 1000 / RANGER 1000 & DIESEL **WORK**

2881485	Cargo Bed Mat	P. 50
2879354	LOOK & RIDE Chainsaw Mount	P. 50
2882752	LOOK & RIDE Bed Extender/Divider	P. 48
2882077	Pro Armor 84 cm - Combo LED Light Bar	P. 61
2882711	Polaris PRO HD 2,041 kg Winch with Rapid Rope Recovery	P. 39
2883279	LOOK & RIDE Storage Box	P. 51
2882384	Wheel & Tire Set: Pro Armor Harvester & Buckle - Matte Black	P. 183
2881533	LOOK & RIDE Tool Rack	P. 51

**COMPLETE LIGHTING WITH REQUIRED
LIGHT BAR HARNESES, SEE P. 52-53**

FULL SIZE RANGER 1000, XP 1000 & DIESEL

ROOFS

POLY VS STEEL*

- Water run-off
- Polaris PULSE Plug & Play
- Liner ready
- Lightweight

- Heavy duty/durable
- Low profile
- Unique style

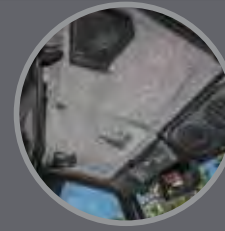

PREMIUM
FINISH &
QUIETER RIDE

TO SHIELD AGAINST DRIVING RAIN OR THE BLISTERING SUN, a roof is the first must-have of the Polaris Engineered cab components. Choose from poly or steel, and get on your way with protective peace of mind.



POLY

Lightweight, durable and impact-resistant. A poly roof can take the abuse of a tough trail and still protect.

PREMIUM ROOF - POLY

» POLARIS PURSUIT CAMO • 2882913

» **TOP SELLER** BLACK • 2882912

XP 1000 '17-21, DIESEL '19-21, 1000 '20-21

INCLUDES ROOF LINER



SPORT ROOF - POLY **TOP SELLER**

» BLACK • 2882911

XP 1000 '17-21, DIESEL '19-21, 1000 '20-21



LINERS

Get a touch of premium comfort, reduce cab noise and hide wiring.

Included with Premium Poly Roofs.

PREMIUM ROOF LINER

» 2882914

XP 1000 '17-21, DIESEL '19-21, 1000 '20-21

WORKS WITH 2882911, 2882912, 2882913



PLUG & PLAY

STEEL ROOFS NOT COMPATIBLE WITH OVERHEAD PULSE

STEEL

For the ultimate in strength and protection.

HD ROOF - STEEL

» 2879881

XP 1000 '17-21, DIESEL '19-21, 1000 '20-21

NOT COMPATIBLE WITH ROOF PULSE SYSTEM

ROOF LINER INCLUDED

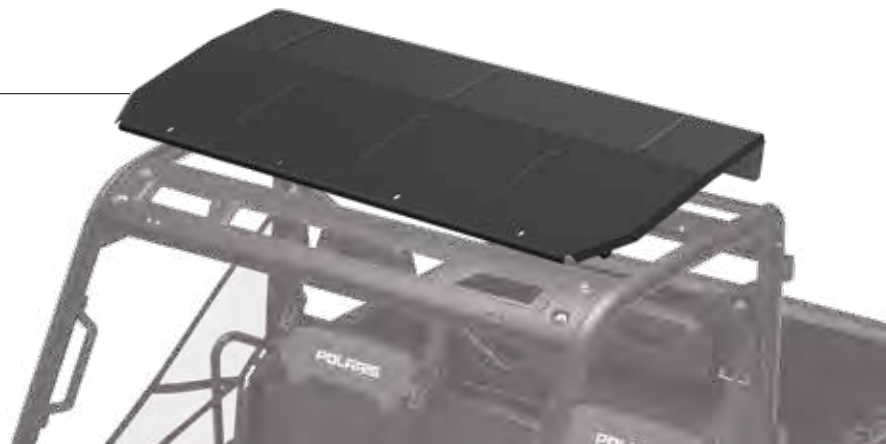



SEALED COVERAGE



REDUCE STANDING WATER



EASY AND FAST INSTALLATION

PREMIUM & SPORT ROOF FEATURES

SEE AUDIO OPTIONS P. 34



*PREMIUM AND SPORT FEATURES NOT AVAILABLE ON STEEL ROOFS

MULTI-FUNCTION LIGHT READY

WINDSHIELD WIPER & WASHER SYSTEM WIRING READY

SOUND ABSORBING LINER

POLARIS PULSE INTEGRATION

AUDIO READY

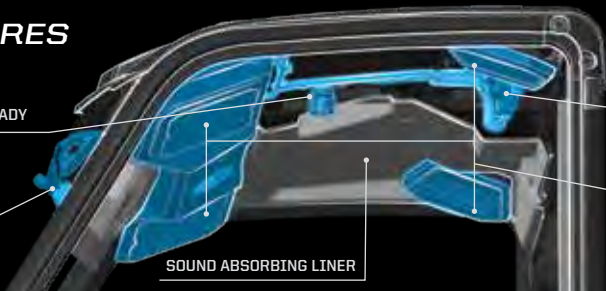

PREMIUM ROOF CREW - POLY

» POLARIS PURSUIT CAMO • 2883277
CREW XP 1000 '17-21, CREW 1000 '20-21
ROOF LINER INCLUDED WITH CAMO



SPORT ROOF CREW - POLY TOP SELLER

» BLACK • 2883274
CREW XP 1000 '17-21, CREW 1000 '20-21,



PREMIUM ROOF LINER - CREW

» 2883457
CREW XP 1000 '17-21, CREW 1000 '20-21,



ADD POWER TO PREMIUM & SPORT ROOFS P. 26

HD ROOF CREW - STEEL

» 2880334
CREW XP 1000 '17-21, CREW 1000 '20-21
NOT COMPATIBLE WITH PULSE BAR

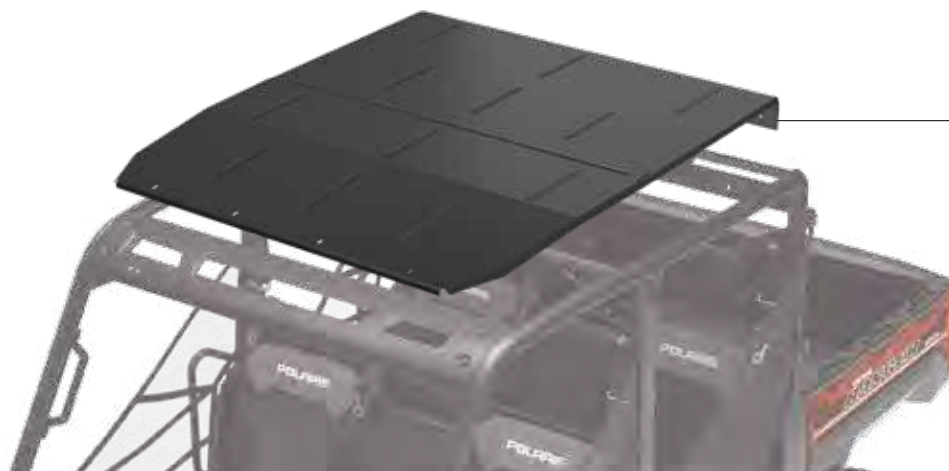

WINDSHIELDS

GLASS VS POLY

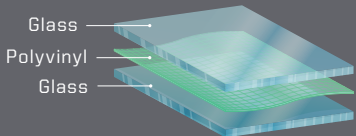

- Superior optical clarity (automotive level)
- Scratch-resistant
- Curved to fit, seals tight
- Cold weather/heavy duty
- Wiper ready

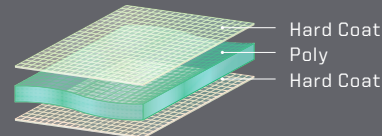

- Lightweight, flexible, easy to store/remove
- Impact-resistant
- 360° seal keeps out rain and dust



NEW LOCK & RIDE
FULL TIP-OUT WINDSHIELD - GLASS

- Tip-out design offers 3 positions - open, closed and vented while featuring a gas strut that assists in easy windshield opening and closing
- Scratch-resistant automotive-style curved glass that provides interior sound dampening and optimized visibility
- Bolt-on design to install directly on the cab frame

» 2889031

XP 1000 '18-21, DIESEL '19-21, CREW XP 1000 '19-21, CREW 1000 '20-21, 1000 '20-21

NEW LOCK & RIDE
FULL GLASS WINDSHIELD - CLEAR

- Scratch-resistant, curved laminate safety glass that protects against wind, rain and other hazardous debris
- UV-blocking interlayer and 360 degree gasket seal
- Seal Kit included

» 2889030

XP 1000 '17-21, DIESEL '19-21, CREW XP 1000 '17-21, CREW 1000 '20-21, 1000 '20-21



LOCK & RIDE
EASY AND FAST
INSTALLATION



**AIRTIGHT
GASKET SEAL**

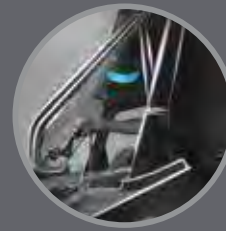

**MULTI-
FUNCTION
FEATURES**

HARD COAT POLY // 30X MORE SCRATCH-RESISTANT



LOCK & RIDE
**FULL WINDSHIELD VENTED -
HARD COAT POLY** TOP SELLER

- Frameless design for maximum visibility
 - Added vents for airflow on a hot day or defrosting on a cold day
 - Requires Wiper Install Kit 2207624
- » 2883266

XP 1000 '17-21, DIESEL '19-21, CREW XP 1000 '17-21, CREW 1000 '20-21, 1000 '20-21



LOCK & RIDE
**FULL WINDSHIELD -
HARD COAT POLY** TOP SELLER

- Frameless design for maximum visibility
 - Requires Wiper Install Kit 2207624
- » 2883300

XP 1000 '17-21, DIESEL '19-21, CREW XP 1000 '17-21, CREW 1000 '20-21, 1000 '20-21



**FLIP-DOWN WINDSHIELD -
HARD COAT POLY** TOP SELLER

- Two venting options: fully sealed, flip-down or remove upper half for some protection with maximum ventilation
- » 2884139

XP 1000 '18-21, DIESEL '19-21, CREW XP 1000 '19-21, CREW 1000 '20-21, 1000 '20-21



LOCK & RIDE
FULL WINDSHIELD - POLY TOP SELLER

- Frameless design for maximum visibility
- » 2883278

XP 1000 '17-21, DIESEL '19-21, CREW XP 1000 '17-21, CREW 1000 '20-21, 1000 '20-21



LOCK & RIDE
HALF WINDSHIELD - POLY TOP SELLER

- Deflects air flow from straight on, but still provides air flow in the cab
- » 2883301

XP 1000 '17-21, DIESEL '19-21, CREW XP 1000 '17-21, CREW 1000 '20-21, 1000 '20-21

ADD ALL-WEATHER VISIBILITY
WINDSHIELD WIPER & WASHER SYSTEM
P. 26

**HARD COAT POLY WINDSHIELD
WIPER & WASHER
MOUNTING BRACKET**

- Required to use wiper on 2883266 or 2883300
- » 2207624

XP 1000 '17-21, DIESEL '19-21, CREW XP 1000 '17-21, CREW 1000 '20-21, 1000 '20-21

**REDUCE IN-CAB DUST SWIRL
BY ADDING A REAR PANEL**
SEE P.30

REAR PANELS

GLASS VS POLY

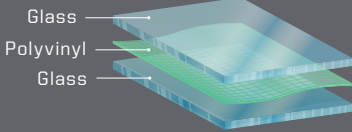

- Superior optical clarity (automotive level)
- Scratch-resistant
- Curved to fit, seals tight
- Cold weather/heavy duty

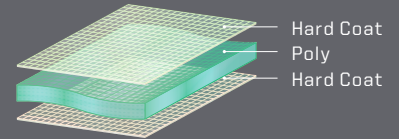

- Lightweight, flexible, easy to store/remove
- Impact-resistant
- Tight seal keeps out rain and dust

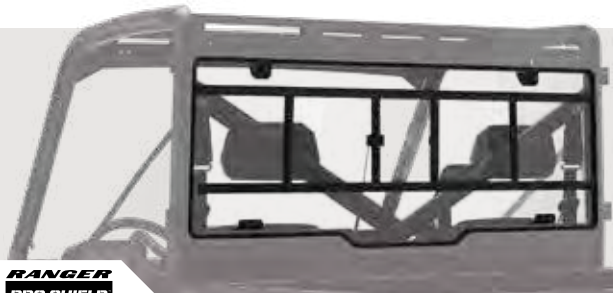

RANGER
PRO SHIELD

LOCK & RIDE

REAR PANEL - SLIDING GLASS

- Sliding window provides ventilation, cab comfort and access to cargo in rear box

» 2879015

XP 1000 '17-21, DIESEL '19-21, CREW XP 1000 '17-21, CREW 1000 '20-21, 1000 '20-21



RANGER
PRO SHIELD

LOCK & RIDE

REAR PANEL - GLASS TOP SELLER

» 2879013

XP 1000 '17-21, DIESEL '19-21, CREW XP 1000 '17-21, CREW 1000 '20-21, 1000 '20-2



LOCK & RIDE
EASY AND FAST
INSTALLATION



**AIRTIGHT
GASKET SEAL**



**VENTING
OPTIONS**



**REDUCE IN-CAB DUST SWIRL
BY ADDING A REAR PANEL**

With a windshield and roof installed, turbulent air develops behind the cab. Add a rear panel to reduce dust intrusion from this swirl.

HARD COAT POLY // 30X MORE SCRATCH-RESISTANT



**RANGER
PRO SHIELD**

LOCK & RIDE

REAR PANEL - POLY POLARIS PURSUIT CAMO

- Strong, thick polycarbonate provides outstanding impact and scratch resistance
- Installs in contours of cab frame with 360° gasketing for outstanding protection, comfort, fit and finish
- Dot matrix screen printing allows for rear visibility

» 2883774

XP 1000 '17-21, DIESEL '19-21, CREW XP 1000 '17-21, CREW 1000 '20-21, 1000 '20-21



**RANGER
PRO SHIELD**

LOCK & RIDE

REAR PANEL - POLY - CLEAR TOP SELLER

- Strong, thick polycarbonate provides outstanding impact and scratch resistance
- Installs in contours of cab frame with 360° gasketing for outstanding protection, comfort, fit and finish

» 2883773

XP 1000 '17-21, DIESEL '19-21, CREW XP 1000 '17-21, CREW 1000 '20-21, 1000 '20-21

DOORS

KEY FEATURES

RANGER PRO SHIELD CAB SYSTEM

WINDOW TYPE / VENTILATION

VISIBILITY

STORAGE COMPARTMENT

AUDIO-READY / SPEAKER MOUNT

PREMIUM TPE LINER

SPECIAL FEATURES

PREMIUM POLY DOORS

POWER WINDOW DOORS	MANUAL CRANK WINDOW DOORS	HALF DOORS
GLASS / POWER	GLASS / MANUAL CRANK	NA / OPEN TOP
UPPER	UPPER	UPPER
STANDARD	STANDARD	STANDARD
STANDARD, PRE-WIRED	STANDARD	
STANDARD	STANDARD	STANDARD
BUILT-IN FLOOR LIGHT, COLORED ACCENT PANELS AVAILABLE	COLORED ACCENT PANELS AVAILABLE	COLORED ACCENT PANELS AVAILABLE
POWER WINDOW • The ultimate door offering power windows, switches mounted on the door and built-in floor light.	MANUAL CRANK WINDOW • A premium, door offering manual crank windows for airflow adjustment in the cab.	HALF • Provides lower protection from the off-road with an open-air experience.

Front and Rear Doors are required to complete a cab on CREW Ranger models.

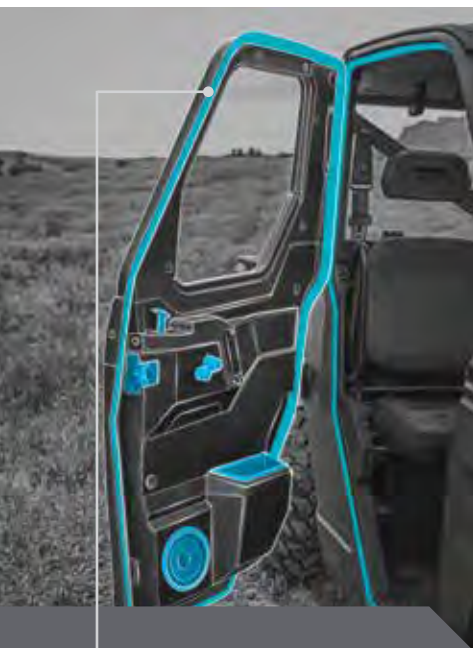

GET SUPERIOR PERFORMANCE AND OUR BEST SEAL with the RANGER Pro Shield Cab System door line

360° GASKET SEAL

EASY TO CLEAN TPE LINER

BUILT-IN STORAGE

AUDIO-READY

VENTILATION OPTIONS

FRONT DOORS

(SET OF 2) XP 1000, '18-21, DIESEL '19-21, CREW XP 1000 '19-21, CREW 1000 '20-21, 1000 '20-21



Power Window Doors - Poly - Black
2884338



TOP SELLER
Manual Crank Window Doors - Poly - Black
2882561



Half Doors - Poly
2882559



Half Doors - Steel
AUST547

REAR DOORS

(SET OF 2) CREW XP 1000 '19-21, CREW 1000 '20-21



Manual Crank Window Doors - Rear - Poly
2883437



Half Doors - Rear - Steel
2883438



Half Doors - Rear - Steel
AUST572 (Rear only)

EXTERIOR DOOR ACCENT PANELS

// Replace stock gloss black accent panels



FRONT 2882870-555
REAR 2883829-555



2882870-685
2883829-685



2882870-756
2883829-756



2883499-342



2882870-686

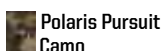

FRONT 2882870-587
REAR 2883829-587



2882870-566
2883829-566



2882870-754
2883829-754





2883499-560
2883843-560









2882870-603

THE BEST CAB COMPLETED

POLY DOORS		CANVAS DOORS
RANGER HUNTER DOORS	RANGER CLEARVIEW DOORS	ZIP WINDOW DOORS
		
GLASS / HINGED	GLASS / HINGED	CLEAR POLY / ZIPPED
UPPER	UPPER + LOWER	UPPER + PARTIAL LOWER
DURABLE POLY CONSTRUCTION, POLARIS PURSUIT CAMO	DURABLE POLY CONSTRUCTION	AVAILABLE IN POLARIS PURSUIT CAMO
RANGER HUNTER <ul style="list-style-type: none"> Tough clear poly shell extends from the bottom of the door until it meets the upper-hinged glass window. Premium Polaris Pursuit Camo pattern offers extensive camo coverage. 	RANGER CLEARVIEW <ul style="list-style-type: none"> Deliver nearly uninterrupted visibility and maximum ambient lighting inside the cab. Tough clear poly shell extends from the bottom of the door until it meets the upper-hinged glass window. 	ZIP WINDOW <ul style="list-style-type: none"> Lightweight, durable protection with adjustable zipper ventilation and see-through bottom panel.

Premium Doors come with Gloss Black Exterior Door Accent Panels, images shown with optional Exterior Door Accent Panels.

		
RANGER Hunter Doors - Polaris Pursuit Camo 2883229	RANGER ClearView Doors 2882901	TOP SELLER Zip Window Doors - Canvas - Black 2882902
		
RANGER Hunter Doors - Rear - Polaris Pursuit Camo 2883633	RANGER ClearView Doors - Rear 2883632	Zip Window Doors - Rear - Canvas - Black 2883634

// Painted plastic and clear-coated for UV protection

// Install easily with a single screw

// Comes as a pair

 Orange Rust
2882870-750

 Matte Titanium
2882870-632
2883829-632

 Steel Blue
2882870-765
2883829-765

 Stealth Gray **NEW**
2882870-804
2883829-804

 Matte Navy **NEW**
2882870-726
2883829-726

 Black Pearl **NEW**
2882870-666
2883829-666

 Suede Metallic
2882870-577

 Sunset Red Metallic
2882870-520
2883829-520

 Matte Sunset Red **NEW**
2882870-669

 Ghost White Metallic **NEW**
2882870-774
2883829-774

 Burgundy Metallic **NEW**
2882870-629
2883829-629

For required Polaris PULSE installation items, see P. 36

CAB COMFORT & CONVENIENCE



8-VENT HEATER & DEFROST SYSTEM



- Easily control the climate inside your cab in any season
- Helps defrost windshields and keeps you warm or cool
- Heat and fan dash-mounted controls
- Manual vents

» **TOP SELLER** 2882753 **XP 1000 ONLY**

XP 1000 '18-21, '19-21, CREW XP 1000 '19-21

» 2884066 **1000 ONLY**

1000 '20-21, CREW 1000 '20-21
NEED ADAPTER: 2884163 ON CREW 1000

» 2884212

DIESEL '17-19

» 2884066

DIESEL '20-21

» **CREW HEATER ADAPTER KIT** **1000 ONLY**

2884163

CREW 1000 '20-21



REDARC DUAL BATTERY KIT

» AUST543-K

1000 '20, XP 1000 '18-21, DIESEL '19-21, CREW MY19-21, PROXD, PROXD CREW '20-21



WINDSHIELD WIPER & WASHER SYSTEM

TOP SELLER



» 2883974

XP 1000 '18-21, DIESEL '19-21, CREW XP 1000 '19-21,
CREW 1000 '20-21, 1000 '20-21

REQUIRES MOUNT KIT 2207624 FOR POLY WINDSHIELDS

HARD COAT POLY WINDSHIELD WIPER & WASHER SYSTEM MOUNTING BRACKET

» 2207624

XP 1000 '17-21, DIESEL '19-21, CREW XP 1000 '19-21, '17-21,
CREW 1000 '20-21, 1000 '20-21

REQUIRED TO USE WIPER ON 2883266 OR 2883300



FLOOR MATS - 3 SEAT

» 2882780 **XP 1000 ONLY**

XP 1000 '18-21, DIESEL '19-21
CREW: FITS FRONT SEATS ONLY

» 2884247 **1000 ONLY**

1000 '20-21, CREW 1000 '20-21
CREW: FITS FRONT SEATS ONLY

CAB SEAL SYSTEM - 3 SEAT



- Included in all Premium and Poly Doors

» 2883253

XP 1000 '18-21, DIESEL '19-21, CREW XP 1000 '19-21,
CREW 1000 '20-21, 1000 '20-21



UNDER SEAT DRY STORAGE

» 2882910 **XP 1000 ONLY**

XP 1000 '18-21, DIESEL '19-21
WILL NOT WORK WITH SUBWOOFER
2882890

NOISE REDUCTION SYSTEM

» 2883489

XP 1000 '18-21, DIESEL '19-21, CREW XP 1000 '19-21,
CREW 1000 '20-21, 1000 '20-21
DESIGNED TO ATTACH TO THE REAR CLOSURE PANEL OF YOUR RANGER CAB, THE SOUND ABSORBING MATERIAL REDUCES UNWANTED NOISE FOR A QUIETER CAB



MULTI-FUNCTION CAB LIGHT



- LED dome light provides white, red, green and blue lighting options
- Battery-operated. Recharges when the vehicle is on
- Can be removed to use as a flashlight in and around your vehicle

- Red light is great for reading maps
- Green light is perfect for navigating in the dark
- Blue light is ideal for night riding

» 2882871

XP 1000 '18-21, CREW XP 1000 '19-21, CREW 1000 '20-21, 1000 '20-21
REQUIRES ROOF PULSE: 2882904

REMOTE GARAGE DOOR OPENER BY HOMELINK

- HomeLink technology allows you to control up to two garage doors



» 2882892

XP 1000 '18-21, DIESEL '19-21, CREW XP 1000 '19-21, CREW 1000 '20-21, 1000 '20-21



POLARIS RANGER XP FULL-SIZE SEATSAVER - SPLIT BENCH SEAT XP 1000 ONLY

- Covers the back and bottom of seat

» POLARIS PURSUIT CAMO • 2883244-587

» CARHARTT BROWN • 2883244-218

» CARHARTT GRAVEL • 2883244-458

XP 1000 '18-21, CREW XP 1000 '19-21, CREW: FITS FRONT SEATS ONLY
NO REAR SEAT COVERS AVAILABLE



FOLDING SIDE MIRRORS

- Will not work with doors fitted

» EMP-11969

900 XP MY13-19, DIESEL MY14-18, XP 1000 MY17, 900 XP CREW MY15-19, DIESEL CREW MY16-18

» 13609

ALL FULL SIZE RANGER '19-21
DOES NOT WORK WITH FULL DOORS



KOLPIN RANGER SIDE MIRROR KIT

- Fits all mid and full size Rangers
- Dual-view lenses for wide viewing range
- Rugged fold-in and break-away design
- Included clamps fit 1 5/8" - 2" round tubing for profile tubes
- Low profile clamp compatible with most windshields and doors
- Package includes a set of two mirrors
- Mirror Dimensions: 3.5"W x 10"H

» 98315

ALL RANGER AND RZR570
FITS FULL DOORS, SEE POLARIS ACCESSORIES TEAM FOR INSTRUCTIONS



CANVAS SEAT COVERS TOP SELLER



» P770Q

FULL-SIZE MY 08-14

» AUST350 - (4 PIECE)

900 XP MY13-19, XP 1000 MY17

» P821Q - (3 PIECE)

DIESEL MY14-18

» P905Q

XP 1000 MY18-21, DIESEL '19-21, XP 1000 CREW MY20, 21 (FRONT)

» P927Q

XP 1000 '19-21, DIESEL '19-21, CREW MY19 (REAR), '19-21, 1000 '20-21 PROXD 20-21, PROXD CREW '20-21 (2)

» P969Q

RANGER 1000EPS '20-21

» P977Q

RANGER EPS PREMIUM '20-21



WORK BEACON LED LIGHT

- 15.2 mof illumination 360° around your vehicle
- Ideal for plowing, hunting and nighttime utility work
- Break-away construction protects the light in areas with tight clearance
- Mounted to the vehicle on the rear of the ROPS
- Easily hinge the light up during use and hinge it down when in transit
- Add LED Headlights for more light

» 2883265

XP 1000 '18-21, CREW XP 1000 '19-21, CREW 1000 '20-21, 1000 '20-21



NEW LED HEADLIGHTS

- LED Headlights offer improved brightness and illumination vs stock halogen lights
- Designed with styling specific to Ranger

» 2889072

XP 1000 '18-21, DIESEL '19-21, XP 1000 CREW '19-21



REVERSE WARNING ALERT

» 2883246

XP 1000 '18-21, DIESEL '19-21, CREW XP 1000 '19-21, CREW 1000 '20-21, 1000 '20-21
AUTOMATICALLY ACTIVATED WHENEVER THE VEHICLE IS PUT IN REVERSE

HORN TOP SELLER



» 2882764

XP 1000 '18-21, DIESEL '19-21, CREW XP 1000 '19-21, CREW 1000 '20-21, 1000 '20-21

LARGE REAR VIEW MIRROR TOP SELLER

» 2879969

XP 1000 '17-21, DIESEL '19-21, CREW XP 1000 '17-21, CREW 1000 '20-21, 1000 '20-21

WIDE ANGLE REAR VIEW MIRROR

- Large 6.4 x 35.6 cm adjustable convex mirrored surface gives you a full-spectrum view

» 2881439

XP 1000 D '17-21, DIESEL '19-21, CREW XP 1000 '17-21, CREW 1000 '20-21, 1000 '20-21

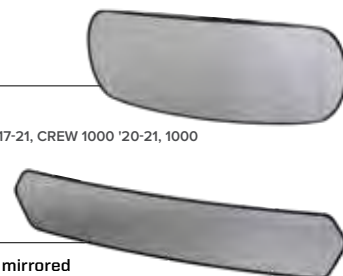

ELECTRICAL ACCESSORIES

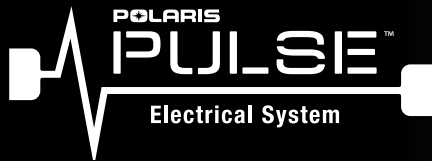

Polaris PULSE is a revolutionary way to provide additional power locations on your vehicle, and makes adding electrical accessories a snap. Electrical accessories are easier to install on the roof, with designated routing areas and plug and play connections. Look for

 to identify Polaris PULSE ready accessories.

ADD ELECTRICAL SYSTEM ACCESSORIES IN 4 EASY STEPS

STEP 1

CHOOSE A POLARIS PULSE READY ROOF	3-SEAT	CREW
Premium Roof - Poly - Polaris Pursuit Camo	2882913	2883277
Premium Roof - Poly - Black	2882912	N/A
Sport Roof - Poly - Black	2882911	2883274

STEP 2

ADD THE POLARIS PULSE ROOF 6		3-SEAT	CREW
Polaris PULSE Roof 6	2882904	X	X

POLARIS PULSE READY ROOF WIRING EXAMPLE

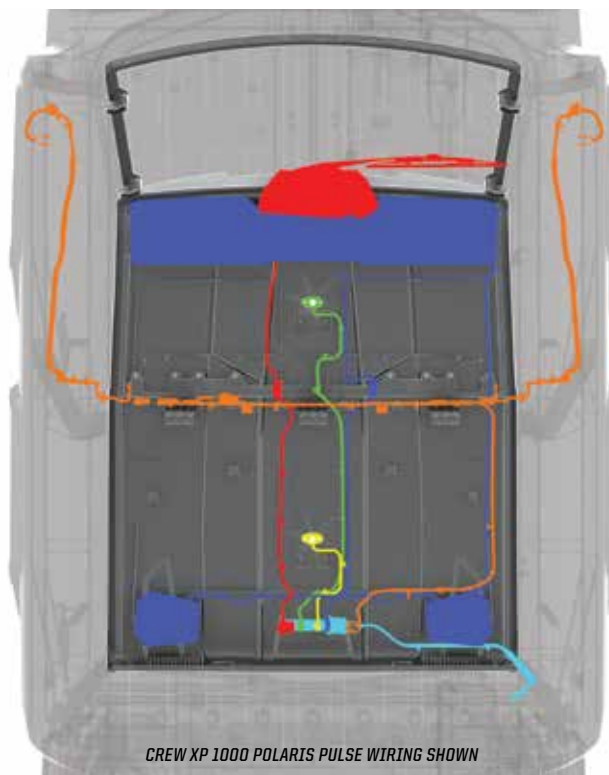

CREW XP 1000 POLARIS PULSE WIRING SHOWN

THE FOLLOWING ACCESSORIES EASILY PLUG INTO THE FACTORY INSTALLED POLARIS PULSE UNDER THE HOOD:

B-Vent Heater & Defrost System	P. 26
Horn	P. 35
Plow Controller	P. 56
160 Watt, Waterproof AM/FM Bluetooth Audio System	P. 46
Light Bars	P. 60



POLARIS PULSE UNDERHOOD BUS BAR - 6 POSITION 1000 ONLY

• If upgrading to more than three accessories attaching to the underhood PULSE location, replace 3-position Bus Bar with the Polaris PULSE Underhood Bus Bar - 6 Position

» 2884183
1000 '20-21, CREW 1000 '20-21

POLARIS PULSE BATTERY TENDER ADAPTER

• Connects your Battery Minder or trickle charger to your vehicle

» 2884297
XP 1000 '18-21, DIESEL '19-21, CREW XP 1000 '19-21, CREW 1000 '20-21, 1000 '20-21



PULSE MALE PLUG

• Accessories power, positive battery power and ground
• Easy wiring for any accessory in to the new Polaris PULSE™ system

» 13564

1000 '21, XP 1000 '18-21, DIESEL '19-21, XP 1000 CREW MY19-21
ALL FULL SIZE RANGERS '18-21, GENERAL 1000/4 '19-21,
GENERAL XP 1000/4 '21

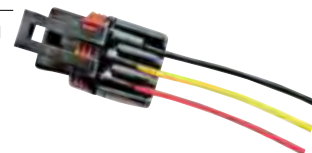



POLARIS
PULSE
Electrical System

**XP 1000
CREW XP 1000
1000
CREW 1000
DIESEL**

STEP 3 ADD ACCESSORIES*

POWER WINDOW DOORS		3-SEAT	CREW
Power Window Doors - Poly - Black	2884338	X	X
Polaris PULSE Wiring Harness - Crew Extension	2883231		X
WINDSHIELD WIPER & WASHER SYSTEM		3-SEAT	CREW
Windshield Wiper & Washer System	2883974	X	X
Polaris PULSE Wiring Harness - Crew Extension	2883231		X
AUDIO: VISOR AUDIO + REAR SPEAKERS		3-SEAT	CREW
300 Watt AM/FM, Bluetooth Audio Visor with Four 16.5 cm Waterproof Speakers	2882888	X	X
Rear Overhead Speakers	2882876	X	X
Polaris PULSE Wiring Harness - Crew Extension	2883231		X
AUDIO: DASH RADIO & VISOR SPEAKERS		3-SEAT	CREW
160 Watt, Waterproof AM/FM Bluetooth Audio System	2882750	X	X
300 Watt Overhead Audio Visor Speakers	2882891	X	X
Polaris PULSE Wiring Harness - Crew Extension	2883231		X
MULTI-FUNCTION DOME LIGHT		3-SEAT	CREW
Multi-Function Cab Light (Front) †	2882871	X	X
Polaris PULSE Wiring Harness - Crew Extension	2883231		X

*Add accessories to models without Ride Command

†To add a Multi-Function Dome light for rear passengers, add an additional 2882871

STEP 4 FINISHING TOUCH

CONCEAL WIRING FOR A FINISHED, COMFORTABLE LOOK	3-SEAT	CREW
Premium Roof Liner	2882914	2883457



EASILY ADD LIGHTING

With Polaris PULSE it's easy to add RIGID and Pro Armor lighting to your RANGER, all LED Light bars listed on P. 60-61 are Polaris PULSE ready, making installation that much easier.

POLARIS PULSE LIGHT BAR WIRING LOCATIONS

**FRONT BUMPER // ROOF - FRONT MOUNTED
ROOF - REAR MOUNTED // *CREW ROOF - REAR MOUNTED**
(*REQUIRES EXTENSION)

1 LIGHT WITH 1 SWITCH

- Polaris PULSE Wiring Harness - 1 LED Light Bar • 2883230

2 LIGHTS WITH 1 SWITCH

- Polaris PULSE Wiring Harness - 1 LED Light Bar • 2883230
- Y-Harness • 2879860

2 LIGHTS WITH 2 SWITCHES

- Polaris PULSE Wiring Harness - 1 LED Light Bar • 2883230
- Polaris PULSE Wiring Harness - 1 LED Light Bar • 2883230

EXTENSIONS FOR CREW

- Polaris PULSE Wiring Harness - 1 LED Light Bar - Crew Extension • 2883231

WINCHES

ADD A PLOW
P. 48

WHETHER HARD AT WORK OR ON THE TRAILS, ADD A WINCH TO...

- GET THE JOB DONE RIGHT
- GET YOU ON YOUR WAY FASTER
- BE PREPARED FOR UNEXPECTED SITUATIONS

WHY POLARIS?



TESTED **1,200+**
PULLS AT MAX LOAD



BUILT TO WITHSTAND
-29° C TEMPERATURES



OPERATES **FULLY**
SUBMERGED



MILITARY
TESTED & APPROVED

UPGRADE YOUR CONTROLS HD OR PRO HD WINCHES

POWER CONTROLLER

- Control winch/plow hydraulics from shift knob

» 2883247

XP 1000 '18-21, DIESEL '19-21, CREW XP 1000 '19-21, CREW 1000 '20-21, 1000 '20-21

CONTROLS HYDRAULICS

REQUIRES WINCH ADAPTER

2884159 WHEN USING A WINCH FOR LIFTING DEVICE



WIRED REMOTE CONTROL

- Must order remote handle and socket together

» REMOTE HANDLE
4013466

» SOCKET
4017102

WORKS WITH ALL MODELS

DASH REMOTE CONTROL

- Must order remote switch and harness together

» REMOTE SWITCH
4017200

» HARNESS
2415055

XP 1000 '18-21, DIESEL '19-21, CREW XP 1000 '19-21, CREW 1000 '20-21, 1000 '20-21

REPLACEMENT PARTS

SYNTHETIC ROPE

2,722 kg
» 2879188

2,041 kg
» 2879187



STEEL CABLE

1,588 kg
» 2878890

FEATURES

ALL POLARIS ENGINEERED WINCHES COME WITH:



1. Set Dial to FREE SPOOL (N) to attach Winch Hook
2. Set Dial to PULL (L) for Winch Mode
3. Set Dial to ROPE RECOVERY (H) for 5x Faster Rope Recovery

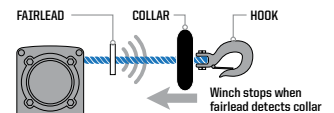

Stops winch at end of pull to prevent driveline stress and plow overlifting



- Lightweight & Easy to Handle
- Superior Flexibility & Strength
- 15 m long



15 m range wireless remote control with unique code for interference-free operation

MODEL

XP 1000 '18-21
CREW XP 1000 '19-21
1000 '20-21
CREW 1000 '20-21
NON EPS RANGER 1000 REQUIRES FRONT BUMPER
DIESEL '19-21

PRO

PRO HEAVY DUTY SERIES

TOP-OF-THE-LINE FEATURES



I-ID

HEAVY DUTY SERIES

BUILT FOR THE OFF-ROAD



PRO

PRO HEAVY DUTY SERIES

I-ID

HEAVY DUTY SERIES



INTEGRATED WIRING, MOUNT, PREASSEMBLED

HOOK WITH STRAP

CUT STEEL GEARS & SEALED DRIVETRAIN

SEALED PERMANENT MAGNET MOTOR



NOT AVAILABLE



WITH ALUMINUM FAIRLEAD

ADD AUTO STOP UPGRADE

» 2883454

WORKS WITH 2882714
SYNTHETIC ROPE REQUIRED



WITH STEEL ROLLER FAIRLEAD



ADD SYNTHETIC ROPE

» 2879187



ADD WIRELESS REMOTE

» 2883455

WORKS WITH 2882714



2,722 kg

2,041 kg

2,041 kg

TOP SELLER
2882710

TOP SELLER
2882711

TOP SELLER
2882714

PROTECTION

HD FRONT BRUSHGUARD with integrated plow mount and mounting locations for seamless installation of lighting accessories. Additional 91.4 cm of storage area is included for the Off-Road Jack Kit or other recovery equipment.



STANDARD BRUSHGUARDS

HD BRUSHGUARDS

PERFECT FOR: **INCREASED PROTECTION AROUND LIGHTING AND FENDERS**

FRONT

INSTALLS DIRECTLY TO STOCK BUMPER



4.4 cm DIAMETER
STEEL TUBE CONSTRUCTION

REAR



CAN BE USED IN CONJUNCTION WITH A TOW HITCH

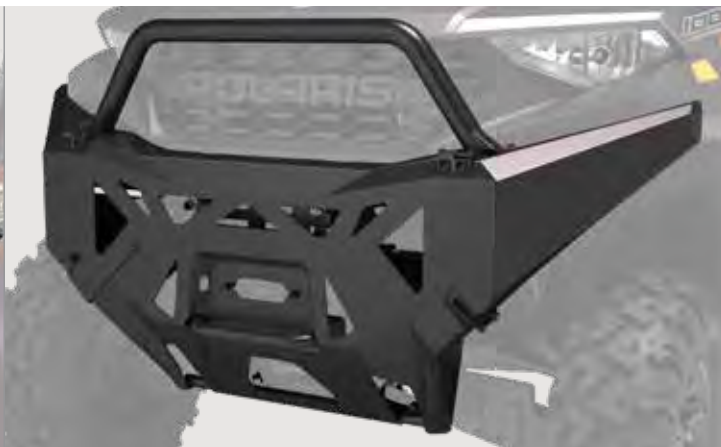

• Requires 2207941 with Ride Command

» FRONT • 2882531 TOP SELLER

» REAR • 2882529 TOP SELLER

XP 1000 '19-21, DIESEL '19-21, CREW XP 1000 '19-21, '19-21, CREW 1000 '20-21, 1000 '20-21
FRONT BRUSHGUARD DOES NOT FIT HIGH LIFTER MODELS
MY 20 RANGER 1000 VEHICLES REQUIRE FRONT BUMPER: 2884123

• For use with vehicles with Ride Command with Front Camera

» RIDE COMMAND BUMPER ADAPTER • 2207941

• Increased protection over stock bumper with integrated mounting locations for accessories and lights (sold separately) with a durable matte black finish

• Easy installation with included mounting hardware

• Additional 36" storage area for recovery equipment

» FRONT • 2885105

» REAR • 2884217

XP 1000 '18-21, DIESEL '19-21, CREW XP 1000 '19-21, '19-21, CREW 1000 '20-21, 1000 '20-21
FRONT BRUSHGUARD DOES NOT FIT HIGH LIFTER MODELS

REAR: RECOMMENDED WITH ANY OF OUR RIGID OR PRO ARMOR
POD LIGHTS FOR UPGRADED LIGHTING

» OFF-ROAD JACK KIT
2881201

ROCK GUARDS



3-SEAT



CREW

ROCK GUARD WITH STEP

- Reliable, hard-working protection for edges of vehicle
- Integrated step with boot scraper helps keep interior clean
- Mounts directly to the frame, instead of underneath, for maximum ground clearance
- Steel construction with black e-coat and durable black powdercoated finish

» **3-SEAT • 2882530**

XP 1000 '18-21, DIESEL '19-21, 1000 '20-21

» **CREW • 2883398**

CREW XP 1000 '19-21,
CREW 1000 '20-21



FRONT BRUSHGUARD

1000 ONLY

- Increased protection over stock bumper
- Sturdy stamped steel and tube construction
- Integrated mounting positions for plow and winch accessories

» **2884123**

1000 '20 CAMO OR IN-MOLD, CREW 1000 '20 CAMO OR IN-MOLD, MY '20 ONLY
REQUIRED TO INSTALL WINCH/PLOW ON NON EPS RANGER 1000



MUD GUARD KIT

» **AUST531**

XP 1000 '19-21, MY 18-21, DIESEL MY19-21, XP 1000 CREW MY19-21, 1000 '21



SNORKEL KIT

» **AUST561 - 2 SNORKELS**

RANGER 1000 20, 21

» **AUST403 - 1 SNORKEL**

RANGER DIESEL '15-18,
RANGER 900 '14-19



HMW A-ARM GUARDS

- Strong, .64 cm thick, durable, lightweight HMW (high molecular weight) polyethylene construction helps protect against off-road impacts
- Molded specifically for the RANGER XP 1000 & 1000 front suspension for a sure fit and low-profile presence
- Easy bolt-on design with mounting hardware included

» **FRONT • 2882784**

XP 1000 '18-21, DIESEL '19-21,
CREW XP 1000 '19-21,
CREW 1000 '20-21, 1000 '20-21
WILL NOT FIT ARCHED A-ARM MODELS

» **REAR • 2882787**

XP 1000 '18-21, DIESEL '19-21,
CREW XP 1000 '19-21,
CREW 1000 '20-21, 1000 '20-21
WILL NOT FIT ARCHED A-ARM MODELS

PROTECTION

ULTIMATE



OZ ARMOUR
MOTORSPORTS

SCRUB BAR AND SIDE RAIL

- Maximum protection from anything thrown at the Ranger
- Full bumper replacement
- One piece front bar

» AUST555

1000 '20-21, XP 1000 '18-21, DIESEL '19-21, CREW '19-21



BULL BAR AND SIDE RAIL KIT

- Does not work with rock sliders or front rack
- Mounts to stock front bumper

» AUST548

1000 '20-21, XP 1000 '18-21, DIESEL '19-21

» AUST516

XP 900 '13-19, DIESEL '14-18



FRONT INNER GUARDS

- Alloy Footwell protection from sticks and rocks thrown from front tyres

» AUST558

1000 '21, XP 1000 '18-21, DIESEL '19-21, XP 1000 '19-21, CREW 19-21

RANGER 1000, XP 1000, DIESEL MY19-21 & CREW

REAR STEP BUMPER

- Steel construction with rear step, works with tow hitch

» AUST599



UNDER BODY PROTECTION



REAR A-ARM GUARDS

» AUST349

900 XP MY13-19, DIESEL MY14-18, XP 1000 MY17, 900 XP CREW MY15-19

» AUST521

XP 1000, CREW MY19-21, 1000 '21, XP 1000 '18-21, DIESEL '19-21

ALUMINUM BASH PLATE INCLUDES SIDES

» AUST351

900 XP MY13-19, DIESEL MY14-18, XP 1000 MY17

» AUST557 **NEW**

XP 1000 CREW '19-21

MUST PURCHASE A-ARM GUARDS SEPARATELY

» AUST570 **NEW**

1000, 1000 XP MY2021

BASH PLATE ONLY (NO A-ARM GUARDS INCLUDED, MUST BE PURCHASED SEPARATELY) 2021 PETROL MODELS

RANGER FULL ALLOY SKID PLATE & A-ARM GUARDS **TOPSELLER**

- Full kit with everything seen in picture

» AUST386

900 XP MY13-19, DIESEL MY14-18, XP 1000 MY17

» AUST523

XP 1000 MY18-20, DIESEL MY19-21

(DOES NOT FIT PETROL 2021)

FRONT A-ARM GUARDS

» AUST348

900 XP MY13-19, DIESEL MY14-18, XP 1000 MY17, 900 XP CREW MY15-19

» AUST522

XP 1000 '18-20, CREW XP 1000 MY19-20, 1000 '21, DIESEL '19-21
(DOES NOT FIT PETROL 2021)

» AUST569 **NEW**

XP 1000, 1000 MY2021

ARCHED A-ARM 2021 PETROL MODELS

TECHNOLOGY

REVOLUTIONIZING THE OFF-ROAD EXPERIENCE



- **BUILT IN GPS WITH TOPOGRAPHY MAPS TO SEE YOUR LOCATION AND PLAN YOUR RIDE**
- **MEDIA PLAYER WITH BUILT IN AM/FM TUNER FOR ALL YOUR FAVORITE MUSIC**
- **GROUP RIDE FOR BUDDY TRACKING, TO SEE YOUR FRIENDS ON THE MAP, TRACK AND SHARE RIDE STATS ON THE DISPLAY OR RIDE COMMAND MOBILE APP**

RIDECOMMAND

RIDE COMMAND 7" DISPLAY



- 7" High Bright Touchscreen visible in all conditions
- Displays critical vehicle information for fuel level, coolant temp and battery voltage
- Media player with built in AM/FM tuner
- Enhanced Group Ride capability to track and share your ride
- Dedicated shortcut buttons for quick access to features
- Bluetooth and USB smart phone connectivity
- Front camera support for better visibility on and off trail
- Includes Plow Mode on XP 1000 '18-21 and CREW XP 1000 '19-21 models (see P. 46 for details)
- Kit comes without AM/FM aerial

» 2884072

XP 1000 '18-21, DIESEL '19-21, CREW XP 1000 '19-21, CREW 1000 '20-21, 1000 '20-21 SPEAKERS NOT INCLUDED. MUST CHOOSE AUDIO PACKAGE FOR AUDIO OUTPUT. IF FITTING WITH UPPER BRUSHGUARD 2882531 OR HOOD RACK 2882690 ALSO REQUIRES 2207941 RIDE COMMAND BUMPER ADAPTOR.

RIDE COMMAND MOUNT KIT



- Mount Ride Command seamlessly into the dash for perfect fit and finish
- Comes with wiring harnesses needed
- Includes front camera

» 2882872

XP 1000 '18-21, DIESEL '19-21, CREW XP 1000 '19-21, CREW 1000 '20-21, 1000 '20-21, ALL NORTHSTAR EDITIONS '18-21

» 2884564

XP 1000 BACKCOUNTRY '19-21, CREW XP 1000 BACKCOUNTRY '19-21, CREW 1000 WINTER PREP '20-21, CREW 1000 '20-21, NORTHSTAR EDITION '21, XP 1000 TRAIL BOSS '21, CREW XP 1000 TRAIL BOSS '21 FOR ALL MODELS WITH 900 WATT STATOR UPGRADE

ADD RIDE COMMAND PLOW MODE HARNESS P. 55

MBQUART®

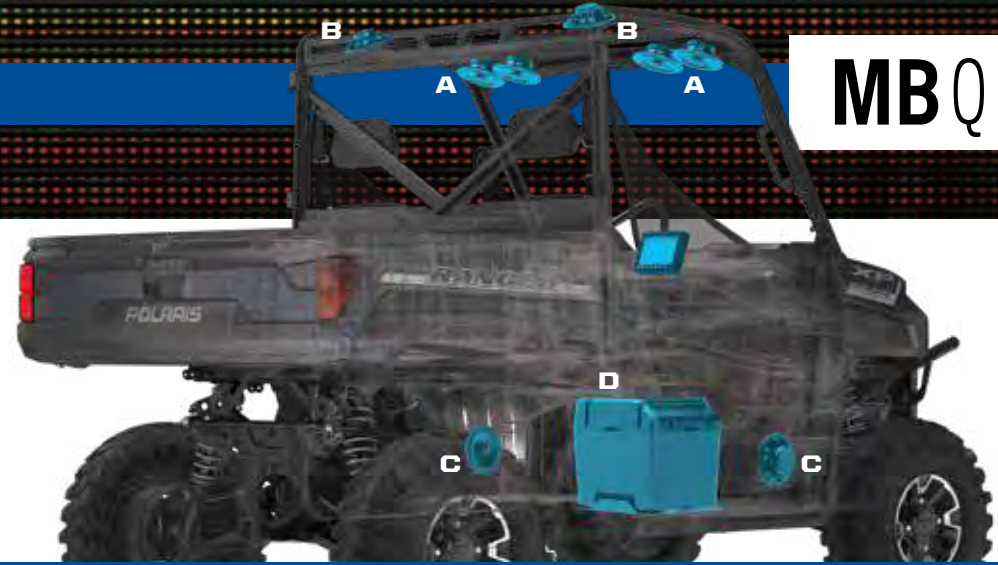

BUILD YOUR SOUND WITH RIDE COMMAND

STEP 1 ADD HEAD UNIT

RIDE COMMAND
2884072

STEP 2 ADD MOUNT

2882872
XP 1000 '18-21, DIESEL '19-21, CREW XP 1000 '19-21, CREW 1000 '20-21, 1000 '20-21
FOR NORTHSTAR AND ALL OTHER MODELS WITHOUT 900 WATT STATOR

OR

2884564
XP 1000 '18-21, DIESEL '19-21, CREW XP 1000 '19-21, CREW 1000 '20, 1000 '20
FOR 900 WATT STATOR

STEP 3 UPGRADE AUDIO BY ADDING VISOR OR DASH AUDIO

OPTION 1 VISOR AUDIO

OPTION 1
VISOR AUDIO

A. OVERHEAD VISOR SPEAKERS
2882891
HARNESS REQUIRED
2882904
CREW MODELS REQUIRE ADDITIONAL 2883231
AUDIO ANTENNA KIT
NEW 2889044
REQUIRED FOR AM/FM

B. REAR OVERHEAD SPEAKERS + **C. DOOR SPEAKERS** + **D. 25.4 cm MAXBOOST SUBWOOFER**

2882876 OR 2882889 OR 2884233
XP 1000 '18-21, DIESEL '19-21, CREW XP 1000 '19-21, CREW WITH 900 WATT STATOR

OPTION 2 DASH AUDIO

OPTION 2
DASH AUDIO

AUDIO DASH SPEAKERS
2883956

B. REAR OVERHEAD SPEAKERS OR **C. DOOR SPEAKERS** + **D. 25.4 cm MAXBOOST SUBWOOFER**

2882876 OR 2882889 OR 2884233
RANGER MODELS WITH RIDE COMMAND PACKAGE REQUIRE 2883232 ADAPTER HARNESS

AUDIO DASH SPEAKERS INCLUDE BUILT-IN FOUR CHANNEL AMPLIFIER (40-WATTS) AND TWO OFF-ROAD GRADE 13.3 cm SPEAKERS

DOWNLOAD THE RIDE COMMAND MOBILE APP



TECHNOLOGY BUILD YOUR AUDIO SYSTEM

OFF-ROAD GRADE AUDIO

MB Quart, combined with Polaris, engineers Off-Road Grade Audio equipment that's proven to deliver the loudest, crispest sound in the harshest conditions. Rain, snow, mud, heat, cold, dust—**ANY PLACE YOUR RANGER EXCELS, SO WILL YOUR AUDIO.**

1 CHOOSE A HEAD UNIT Control all aspects of your sound system. Choose what to listen to and how loud.

DASH STEREO



160 WATT, WATERPROOF AM/FM BLUETOOTH AUDIO SYSTEM



- All-in-one solution for giving your vehicle a performance-ready sound system
- USB input, Bluetooth 4.0 compatible, Apple Control, AM/FM tuner
- Built-in four channel amplifier (40-watts x 4)
- Two off-road grade 13.3 cm speakers with Titanium Dome Tweeters and Polypropylene Cones

› 2882750

XP 1000 '18-21, DIESEL '19-21, CREW XP 1000 '19-21, CREW 1000 '20-21, 1000 '20-21

USE AS IS OR
ADD ADDITIONAL SPEAKERS

VISOR STEREO



300 WATT AM/FM, BLUETOOTH AUDIO VISOR WITH FOUR 16.5 cm WATERPROOF SPEAKERS TOP SELLER



- One-step solution for off-road audio
- USB input, Bluetooth 4.0 compatible, Apple Control, AM/FM tuner
- 300-Watt four channel amplifier (75 watts x 4)
- 4 16.5 cm coaxial speakers with Titanium Dome Tweeters and Polypropylene Cones
- Audio outputs to drive additional speakers
- 4 Accessory knocks outs
- Polaris PULSE Electrical System

› 2882888

XP 1000 '18-21, DIESEL '19-21, CREW XP 1000 '19-21, CREW 1000 '20-21, 1000 '20-21

NOT COMPATIBLE WITH RIDE COMMAND

COMES WITH OVERHEAD VISOR SPEAKERS (AT RIGHT)
USE AS IS OR ADD ADDITIONAL SPEAKERS

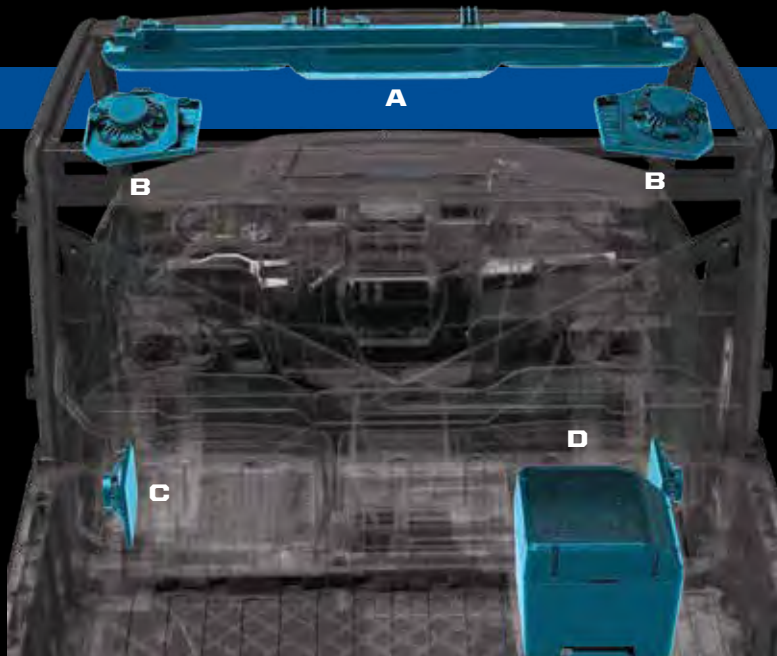

2 ADD SPEAKERS - MIX AND MATCH

Your RANGER is ready for work, but is it ready to entertain? From a simple two-speaker setup to a complete system - add speakers to **BUILD IT YOUR WAY.**

A VISOR SPEAKERS



STANDARD WITH VISOR STEREO

300 WATT OVERHEAD AUDIO VISOR SPEAKERS

- Built-in 300-Watt amplifier (75-watt x 4 channels)
- Four 16.5 cm speakers located in the overhead
- Waterproof system for reliable power and sound quality

» 2882891

XP 1000 '18-21, DIESEL '19-21, CREW XP 1000 '19-21, CREW 1000 '20-21, 1000 '20-21

B OVERHEAD SPEAKERS



REAR OVERHEAD SPEAKERS

- Two 16.5 cm rear roof mounted speakers with Titanium Dome Tweeters and Polypropylene Cones
- Easy install
- Waterproof system for reliable power and sound quality

» 2882876

XP 1000 D '18-21, DIESEL '19-21, CREW XP 1000 '19-21, CREW 1000 '20-21, 1000 '20-21

C DOOR SPEAKERS



16.5 cm WATERPROOF DOOR SPEAKERS

- Two 16.5 cm waterproof speakers with Titanium Dome Tweeters and Polypropylene Cones
- Easy install on manual or power window doors

» 2882889

XP 1000 '18-21, DIESEL '19-21, CREW XP 1000 '19-21, CREW 1000 '20-21, 1000 '20-21

D SUBWOOFER



MAX BOOST 25.4 CM 250 WATT SUBWOOFER XP 1000 ONLY

- Built-in 250-watt amplifier powering 25.4 cm waterproof subwoofer
- Fits RANGER XP 1000 with flip-up passenger seat

» 2882890

XP 1000 '18-21, DIESEL '19-21, CREW XP 1000 '19-21
NOT COMPATIBLE WITH RIDE COMMAND
WILL NOT FIT WITH 2882910 STORAGE INSTALLED

3 MAKE IT WORK

VISOR STEREO HEAD UNIT

VISOR SPEAKERS

POLARIS PULSE ROOF 6

- Required with Visor Stereo (2882888)
- Required to add Visor Speakers (2882891)

» TOP SELLER 2882904

XP 1000 '18-21, DIESEL '19-21, CREW XP 1000 '19-21, CREW 1000 '20-21, 1000 '20-21

CREW MODELS

CREW EXTENSION

- Required for all Crew models where Polaris PULSE Roof 6 Harness (2882904) is required

» 2883231

XP 1000 '20-21, DIESEL '19-21, CREW XP 1000 '19-21, CREW 1000 '20-21

NEW JAN 21 AVAILABILITY

GEOFENCING KIT

- Keep vehicle operators safe by quickly setting and controlling ride boundaries such as speed limits within and outside the geofenced area
- Ensure operators are riding at the appropriate speed for their experience and terrain by setting a max speed from your Ride Command app
- Activate passcode protection and to have full control of who and when the vehicle is being operated

» 2884779

1000 '20-21, CREW 1000 '20-21

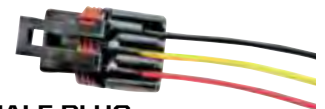

PULSE MALE PLUG

- Accessories power, positive battery power and ground
- Easy wiring for any accessory in to the new Polaris PULSE® system

» 13564

1000 '21, XP 1000 '18-21, DIESEL '19-21, CREW MY19-21

STORAGE

LOCK & RIDE

EXCLUSIVE TO POLARIS, LOCK & RIDE ACCESSORIES LET YOU QUICKLY CHANGE FROM ONE TASK TO ANOTHER WITH HUNDREDS OF OPTIONS.



WITH THE FLIP OF A LEVER, LOCK & RIDE PLUNGERS USE OUTWARD PRESSURE TO EXPAND FOR A SECURE FIT.



CARGO BED REAR WINCH



- Assists lifting heavy objects like hay bales or big game up into rear cargo bed
- 136 kg winch mounts high on rear cab frame
- Equipped with 4.6 m of premium synthetic rope

» 2884215

XP 1000 '18-21, DIESEL '19-21, CREW XP 1000 '19-21, CREW 1000 '20-21, 1000 '20-21

REQUIRES ROOF PULSE: 2882904



LOCK & RIDE FRONT BRUSHGUARD STORAGE RACK

- Allows extra storage space in front of your vehicle
- Accommodates a Polaris Northstar 28 L Cooler or similar sized items
- Attaches and removes easily
- Mounts to existing plow mounting points

» 2883971

XP 1000 '18-21, DIESEL '19-21, CREW XP 1000 '19-21, CREW 1000 '20-21, 1000 '20-21



LOCK & RIDE TONNEAU COVER

- Protects items stored in cargo bed from the elements
- HDPE construction on steel sub-frame can support up to 45.4 kg on top of cover
- Molded storage area for Polaris Northstar 28 L Cooler
- Convenient hinged middle panel for easy access
- Easy installation with Lock & Ride

» 2884218

XP 1000 '18-21, DIESEL '19-21, CREW XP 1000 '19-21, CREW 1000 '20-21, 1000 '20-21



LOCK & RIDE

TIP-DOWN HEADACHE RACK

- Rack tips down for additional storage solutions with space below and multiple tie-down points
- Lightweight and heavy-duty rack protects the cab of your RANGER and lets you haul even more

» 2881531

XP 1000 '17-21, DIESEL '19-21, CREW XP 1000 '17-21, CREW 1000 '20-21, 1000 '20-21
DOES NOT FIT HIGH LIFTER MODELS



LOCK & RIDE

CARGOMAX SYSTEM

- Comes standard with a support bar that ties the two sides together for a sturdy cargo hold
- Designed to attach to the Lock & Ride Tip-Down Headache Rack for additional support and three-sided containment
- Adjustable utility hooks provide more options for hanging tools, cords or gear

» 2882177

XP 1000 '17-21, DIESEL '19-21 CREW XP 1000 '17-21, CREW 1000 '20-21, 1000 '20-21



LOCK & RIDE

BED EXTENDER/DIVIDER

- Extend or divide the cargo box
- Installs in any location in the box
- Multiple tie-down points available to secure cargo

» 2882752

XP 1000 '18-21, DIESEL '19-21, CREW XP 1000 '19-21, '19-21, CREW 1000 '20-21, 1000 '20-21



FRONT HOOD STORAGE RACK

- Front curve helps keep cargo in place when traveling
- Provides additional protection
- Fully integrated pivots to gain under-hood access
- Requires Bumper Adapter 2207941 with Ride Command

» 2882690

XP 1000 '18-21, DIESEL '19-21, CREW XP 1000 '19-21, CREW 1000 '20-21, 1000 '20-21
DOES NOT FIT WITH BUMPER 2882531
REQUIRES 2207941 TO WORK WITH RIDE COMMAND CAMERA



75+ COMBINATIONS TO MAKE IT YOUR OWN

With a full line of Lock & Ride accessories, you can haul more and do more. Use the chart below to see what combinations work together.

POLARIS RANGER STORAGE MATRIX XP 1000 / 1000 570 FULL-SIZE		LOCK & RIDE Tip-Down Headache Rack	LOCK & RIDE CargoMax System	LOCK & RIDE Bed Extender/Divider	LOCK & RIDE Storage Box	LOCK & RIDE Tool Rack	LOCK & RIDE Chainsaw Mount	LOCK & RIDE 60 Gallon Boomless Utility Sprayer	Cargo Bed Rear Winch	LOCK & RIDE Front Brushguard Storage Rack	LOCK & RIDE Tonneau Cover	Cargo Bed Mat
		2881531	2882177	2882752	2883279	2881533	2879354	2879799	2884215	2883971	2884218	2882751
LOCK & RIDE	Tip-Down Headache Rack	2881531	✓	✓	✓		✓	✓		✓		✓
LOCK & RIDE	CargoMax System	2882177	✓		✓ ²					✓		✓
LOCK & RIDE	Bed Extender/Divider	2882752	✓		✓		✓		✓	✓		✓
LOCK & RIDE	Storage Box	2883279	✓	✓ ¹		✓	✓		✓	✓		✓
LOCK & RIDE	Tool Rack	2881533		✓	✓		✓		✓	✓		✓
LOCK & RIDE	Chainsaw Mount	2879354	✓	✓	✓	✓		✓	✓	✓		✓
LOCK & RIDE	60 Gallon Boomless Utility Sprayer	2879799	✓			✓			✓	✓		✓
	Cargo Bed Rear Winch	2884215		✓	✓	✓	✓	✓		✓		
LOCK & RIDE	Front Brushguard Storage Rack	2883971	✓	✓	✓	✓	✓	✓	✓		✓	✓
LOCK & RIDE	Tonneau Cover	2884218								✓		✓
	Cargo Bed Mat	2882751	✓	✓	✓	✓	✓	✓	✓	✓	✓	

¹ Storage box at front of cargo box if not used with Tip-down Headache Rack

² Storage box at front of cargo box

LOCK & RIDE QUICKSTRAP

- The quickest and most secure way to mount Polaris accessories
- Sold as a pair
- » 2882187
ALL COOLERS,
RANGER CARGO BOXES



LOCK & RIDE D-RINGS

- The most versatile Lock & Ride accessory - add as many as you need to secure your cargo with bungee cords or straps
- » 2881545
ALL RANGER CARGO BOXES



3.8 cm x 4.6 m 2495 kg RATCHET STRAP

- Heavy duty webbing
- 2,495 kg Maximum Load / Working Load
- 2 Pack
- » 2884031

5.1 cm x 6.1 m 4536 kg RATCHET STRAP

- Heavy duty webbing
- 4,536 kg Maximum Load / 1,497 kg Working Load
- Floating D-Rings & Double J-Hooks
- » 2884032

STORAGE

LOCK & RIDE

CHAINSAW MOUNT

- Can be secured to the outside of the bed wall so your chainsaw is within reach at all times

» 2879354

XP 1000 '17-21, DIESEL '19-21, CREW XP 1000 '19-21, '17-21, CREW 1000 '20-21, 1000 '20-21



GOLDACRES 200-LITRE SPOTMATE SPRAYER

- Utilise the traction of your RANGER to spray in areas difficult to reach by tractor or ute.
 - This spray unit should only be used on vehicles with sufficient carrying capacity.
 - 1000L x 700W x 560H
 - 6.8L/m 107 psi Shurflo pump
 - Dry weight 20.5 kg
- » AUST05
ALL RANGERS



BED ESSENTIALS

FIRE EXTINGUISHER HOLDER

- Only holds a 8.3 cm diameter extinguisher
- Quick release strap allows for easy use

» 2882158

XP 1000 '17-21, DIESEL '19-21, CREW XP 1000 '17-21, CREW 1000 '20-21, 1000 '20-21



ELECTRONIC CARGO BOX LIFT

» 2884141

XP 1000 '18-21, DIESEL '19-21, CREW XP 1000 '19-21, CREW 1000 '20-21, 1000 '20-21



RIDE & REPAIR ESSENTIALS KIT

» 2881207

ALL RANGER MODELS



CARGO BED MAT

- Non-slip surface to better secure loads and keep cargo bed clean

» 2882751

XP 1000 '18-21, DIESEL '19-21, CREW XP 1000 '19-21, CREW 1000 '20-21, 1000 '20-21



TOW & HAUL



TOW BALL

- » TB501
- 50 mm
- 1" Shank



5 cm BALL MOUNT

- » 5 cm RECEIVER 2875320



3:1 HITCHES

- » 5 cm x 5 cm RECEIVER 2830522
- » 3 cm x 3 cm RECEIVER 2830523
- » 4.8 cm REPLACEMENT BALL 2830524

ALL RANGER MODELS



FRONT MOUNT RECEIVER HITCH

- Standard 5 cm receiver mount bolts directly to the frame
- UTV attachment works with Polaris bumpers
- Rated at 45.4 kg tongue weight and 453.6 kg towing

» 2882782

XP 1000 '18-21, DIESEL '19-21, CREW XP 1000 '19-21, CREW 1000 '20-21, 1000 '20-21



TASK-SPECIFIC TOOLS

LOOK & RIDE TOOL RACK

- Attach on the inside or outside of the cargo bed
- » 2881533
XP 1000 '17-21, DIESEL '19-21, CREW XP 1000 '17-21, CREW 1000 '20-21, 1000 '20-21



ORGANIZE & PROTECT

LOOK & RIDE STORAGE BOX

- Enough room to store all the tools you need to get the job done
- Internal organizational dividers keep gear from rolling around
- Easily detaches from vehicle
- » 2883279
XP 1000 '17-21, DIESEL '19-21, CREW XP 1000 '17-21, DIESEL '19-21, CREW 1000 '20-21, 1000 '20-21



DO MORE

COOLERS
SEE P. 194



HUNT
SEE P. 52



COLD WEATHER
SEE P. 58



LIGHTING
SEE P. 60



PROTECTING YOUR ESSENTIAL GEAR SINCE 1943



KOLPIN STRONGHOLD SYSTEM

Polaris is proud to partner with Kolpin Outdoors, an industry leader in off-road accessories and the premier name in gun boots and mounts. If you need to secure a firearm or a pop-up blind while riding, simply attach the auto-latch mount and choose your case.

IDEAL FOR SECURE TRANSPORT OF SCOPED RIFLES AND SHOTGUNS

STEP 1 CHOOSE YOUR MOUNT

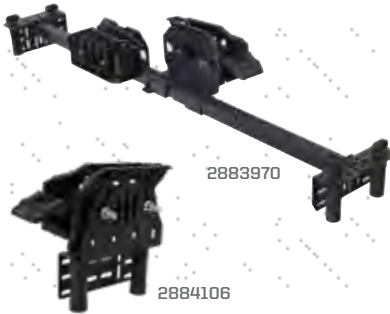

STEP 2 CHOOSE YOUR BOOTS



LOCK & RIDE KOLPIN STRONGHOLD AUTO-LATCH DOUBLE BOOT MOUNT

- Precision angle adjustable for a custom fit
- Provides a quick and secure attachment point
- » DOUBLE BOOT MOUNT • 2883970
- » SINGLE BOOT MOUNT • 2884106

KOLPIN STRONGHOLD GUN BOOT XL – TRANSPORT

- 132 cm L x 9.5 cm W x 26.7 cm H
- » 2882430
- Requires Auto-Latch Mount (2883970 or 2884106)

KOLPIN STRONGHOLD GUN BOOT L

- 132 cm L x 12 cm W x 23.5 cm H
- » 2882426
- Requires Auto-Latch Mount (2883970 or 2884106)

KOLPIN STRONGHOLD POP-UP BLIND/ICE AUGER BOOT

- 116.8 cm L x 31.8 cm W
- » 2882427
- Requires Auto-Latch Mount (2883970 or 2884106)

LOCK & RIDE GUN RACK 6

- Adjustable to store guns at an angle or vertical (shown at angle)
- Holds 6 rifles or shotguns securely with soft rubber v-grips
- Stock is secured in place with a soft molded rubber inlay along the bottom of the rack
- Rack can be adjusted into 3 positions based on firearm height
- » 2882159
- XP 1000 '17-21, DIESEL '19-21, CREW XP 1000 '17-21, CREW 570 FULL-SIZE '18-21, CREW 1000 '21, 570 FULL-SIZE '17-21, 1000 '20-21





CARGO BED REAR WINCH

- Assists lifting heavy objects like hay bales or big game up into rear cargo bed
- 136 kg winch mounts high on rear cab frame
- Equipped with 4.6 m of premium synthetic rope

» 2884215

XP 1000 '19-21, DIESEL '19-21, '18-21, CREW XP 1000 '19-21, CREW 1000 '20-21, 1000 '20-21



IN-CAB GUN MOUNT

- Gives you instant gun access in the field
- Mounts securely to the floor and adjusts up to 45° forward
- Robust, molded gun butt holder at base
- Quick-release barrel straps
- Easily removable
- Accommodates scope-equipped rifles

» 2883263

XP 1000 '18-21, DIESEL '19-21, CREW XP 1000 '19-21, CREW 1000 '20-21, 1000 '20-21
NORTHSTAR EDITION REQUIRES 2208023
HWD KIT TO INSTALL ON THE 2019 AND NEWER MODELS

POLARIS PURSUIT CAMO SxS FIELD COVER

- Full-coverage camo print cover hides your side-by-side while in the field
- Lightweight material protects your RANGER from inclement weather

» 2882160

XP 1000 '17-21, DIESEL '19-21, EV '11-21, 570 FULL SIZE '17-21, 570 '14-21, 500 '11-21, 1000 '20-21

» 2883419 BLACK

» XP 1000 '17-21, DIESEL '19-21, EV '11-21, 570 FULL SIZE '17-21, 570 '14-21, 500 '11-21, 1000 '20-21

KOLPIN RHINO GRIPS IDEAL FOR CARRYING RIFLES, SHOTGUNS, BOWS AND CROSSBOWS



LOCK & RIDE

RHINO GRIP PRO

» 2884107

ALL RANGER MODELS (EXCEPT 150)



LOCK & RIDE

RATCHETING RHINO GRIP

» 2881575

ALL RANGER MODELS (EXCEPT 150)



LOCK & RIDE

RHINO GRIP XLR

» 2881574

ALL RANGER MODELS (EXCEPT 150)



LOCK & RIDE

RHINO GRIP XLR DOUBLES

» 2884108

ALL RANGER MODELS (EXCEPT 150)



RHINO GRIP PRO REPLACEMENT RUBBER STRAPS

» 2884109

RHINO GRIP PRO



NEW

HEAVY-DUTY XLR REPLACEMENT RUBBER STRAPS (2)

» 2889204

RHINO GRIP XL



Never transport a loaded firearm. Verify firearm is unloaded prior to mounting. Please refer to local laws and regulations regarding the requirements for the legal transport of firearms.



COLD WEATHER

POLARIS PLOW MODE

EXCLUSIVE TO RANGER XP 1000 RIDE COMMAND FOR 2020 AND 2021

RIDE COMMAND 7" DISPLAY

» 2884072

XP 1000 '19-21, DIESEL '19-21, CREW XP 1000 '19-21, CREW 1000 '20-21, 1000 '20-21

SEE P. 44

PLOW MODE FUNCTIONALITY DOES NOT CONTROL HYDRAULIC LIFT AND ANGLE



PLOW IS AUTOMATICALLY RAISED WHEN SHIFTING INTO REVERSE



BACK DRAG MODE ALLOWS FOR PULLING SNOW AWAY FROM BUILDINGS



PROSPECTOR PRO TRACK MOUNTS

• Install this track system mounting hardware in place of tires and wheels. Tracks sold separately.

» 2889069 **NEW Q1 2021**

XP 1000 '19-21, CREW XP 1000 '19-21, 1000 21, CREW 1000 '21
FITS MODELS WITH HIGH CLEARANCE A-ARMS

» 2882783

XP 1000 18-21, DIESEL '19-21, CREW XP 1000 '19-21, 1000 20, CREW 1000 '20
DOES NOT FIT HIGH LIFTER MODELS

» 2880071

CREW 570-4 '15-21, 570 '14-21, 500 '17-21

PROSPECTOR PRO TRACK

» 2880758

570 FULL-SIZE 16-21 WITH EPS, 570-2 '14-21 WITH EPS, CREW 570-2 '14-21 WITH EPS
DOES NOT FIT HIGH LIFTER MODELS

» 2883313

XP 1000 '18-21 WITH EPS, DIESEL '19-21, CREW XP 1000 '19-21 WITH EPS, 1000 20-21 WITH EPS, CREW 1000 20-21 WITH EPS
DOES NOT FIT HIGH LIFTER MODELS

» 2880757

XP 1000 '18-21 WITH OUT EPS, DIESEL '19-21, CREW XP 1000 '19-21 WITH OUT EPS, 1000 20-21 WITH OUT EPS, CREW 1000 20-21 WITH OUT EPS, 570 FULL-SIZE 16-21 NON EPS, 570-2 '14-21 WITH OUT EPS, CREW 570-2 '14-21 WITH OUT EPS

POLARIS-SPECIFIC GEARING PROVIDES 1:1 RATIO TO:

- Minimize track slip, providing better climbing ability and improved traction in deep snow
- Improve top speed over prior models by approximately 5%
- Reduce operating RPM for a quieter ride
- Improve driveline durability, which allows vehicle to run at a lower RPM, decreasing engine wear

Polaris Exclusive optimized hub geometry that minimizes feedback and eases steering effort

New front dual stabilizer for improved stability

Lightweight design provides for better flotation, eases steering effort, and provides better vehicle control



For year-round use, Polaris recommends the use of Intake Update Kit (2880673) on any Ranger XP 1000 '17, Ranger XP 1000 CREW '14-18 with tracks installed. To keep intake system working optimally, this kit pre-filters out fine snow and dust.

If using Glacier Pro Plow System with tracks, Track Plow Extension is required (2889267)

GLACIER[®] PRO HD

PLOW SYSTEM

HYDRAULIC CONTROL FOR EXTREME

SNOW REMOVAL

A robust frame and tough blades, combined with a convenient hydraulic angle system, allow your Glacier Pro HD to move serious snow while you remain comfortable. Thanks to Lock & Ride technology, the Pro HD comes standard with a convenient kickstand attachment to the plow frame, giving you the easiest attachment.

3-SEAT & CREW GLACIER PRO HD

» 183 cm Blades

» Choice of poly or steel

» Hydraulic lift & angle system option



BLADE MATERIAL
Durable poly and steel blades are designed to push more. Choose a steel blade for longevity and increased rigidity or a lightweight non-stick, poly blade that's easier on plowing surfaces.

	STEP 1 SELECT A MOUNT	STEP 2 SELECT A FRAME	STEP 3 SELECT PLOW CONFIGURATION		STEP 4 SELECT A BLADE
MODELS	MOUNT	FRAME	HYDRAULICS	WINCHES	BLADES
XP 1000 '18-21 CREW XP 1000 '19-21 1000 '20-21 CREW 1000 '20-21	<p>Not Required Integrated into Factory Bumper</p> <p>NON EPS RANGER 1000 REQUIRES FRONT BUMPER</p>	<p>TOP SELLER 2883255</p> <p>Track Extension 2879871</p> <p>Replacement T Shear Pin 2204829</p> <p>Glacier PRO HD Kickstand System 2207382</p>	<p>Hydraulic Lift System 2883410</p> <p>Glacier Pro HD Plow Hydraulic Angle System 2885103</p> <p>Power Controller Required for hydraulic components 2883247</p>	<p>Polaris PRO HD 2,722 kg Winch 2882710</p> <p>Polaris PRO HD 2,041 kg Winch 2882711</p> <p>Power Controller Winch Adapter 2884159</p>	<p>183 cm Poly 2879317</p> <p>TOP SELLER 183 cm Steel 2879874</p>

SELECT ACCESSORIES

PLOW BLADE SNOW DEFLECTOR

- » 183 cm • 2858541
- » 168 cm • 2879866
- » 152 cm • 2871808

HEAVY DUTY SNOW PLOW DEFLECTOR

- » 183 cm • 2884160

QUICK RELEASE SKID SHOES

- Helps prevent blade wear
- Hardened steel for industrial strength
- » 2205223

COIL SPRING SPACER

- Keep the front end of the vehicle up and improve ride quality when using a plow on strut or A-arm vehicles
- » 2872655



**2-SEAT & CREW
570 FULL-SIZE & CREW**

GLACIER PRO HD

» 183 cm OR
168 cm Blades

» Choice of
poly or steel

» Hydraulic angle
system option



HYDRAULIC CONTROL FOR EXTREME SNOW REMOVAL

A robust frame and tough blades, combined with the option to add hydraulic controls, allow your Glacier PRO HD to move serious snow while you remain comfortable. Thanks to Lock & Ride technology, the PRO HD comes standard with a convenient kickstand attachment to the plow frame, giving you the easiest attachment.

43 cm **168 cm POLY BLADE**
BEST FOR CORROSION RESISTANCE

43 cm **168 cm STEEL BLADE**
BEST FOR BIG JOBS YEAR AFTER YEAR

	STEP 1 SELECT A MOUNT	STEP 2 SELECT A FRAME	STEP 3 SELECT PLOW CONFIGURATION	STEP 4 SELECT A BLADE	
MODELS	MOUNT	FRAME	HYDRAULICS	WINCH	BLADES
570 FULL-SIZE '16-21 CREW 570 FULL-SIZE '16-21	2880261 2879106	TOP SELLER 2880260 Track Extension 2880267 Replacement Shear Pin 2205527	Glacier Pro HD Plow Hydraulic Angle System 2885104 Power Controller Required for hydraulic components 2879227	Polaris PRO HD 2,041 kg Winch 2882238	183 cm Steel 2880270 168 cm Poly 2880269 Steel 2880268
570/500/ETX '10-21 CREW 570 '10-21 LI-ION EV & EV '15-21	2880261 2879106		Glacier Pro HD Plow Hydraulic Angle System 2885104 Power Controller Required for hydraulic components 2879227	Polaris PRO HD 2,041 kg Winch 2882238	183 cm Steel 2880270 168 cm Poly 2880269 168 cm Steel 2880268

WEAR BARS

- Protect your plow blade and minimize wear on the actual blade by installing Wear Bars
- » 183 cm • 2204976
- » 168 cm • 2879867
- » 152 cm • 2877243

QUICK RELEASE SKID SHOES

- Helps prevent blade wear
- Hardened steel for industrial strength
- » 2208864

PLOW MARKER

- Helps driver monitor plow blade position
- Sold in pairs
- » 2872726

PLOW LINK

- » 2204974

GLACIER[®] HD

PLOW SYSTEM

MAKE QUICK WORK OF THE SMALLER JOBS

Move some snow with the sturdy and capable Glacier HD plow system, and discover why a major snowfall can be the highlight of your week. With a robust frame, beefy poly and steel blade options, convenient Lock & Ride mounting and dismounting and amazing value, Glacier HD is a great choice in the dead of winter.

3-SEAT & CREW GLACIER HD

» 183 cm OR
168 cm Blades

» Choice of
poly or steel

» Manual angle
system standard

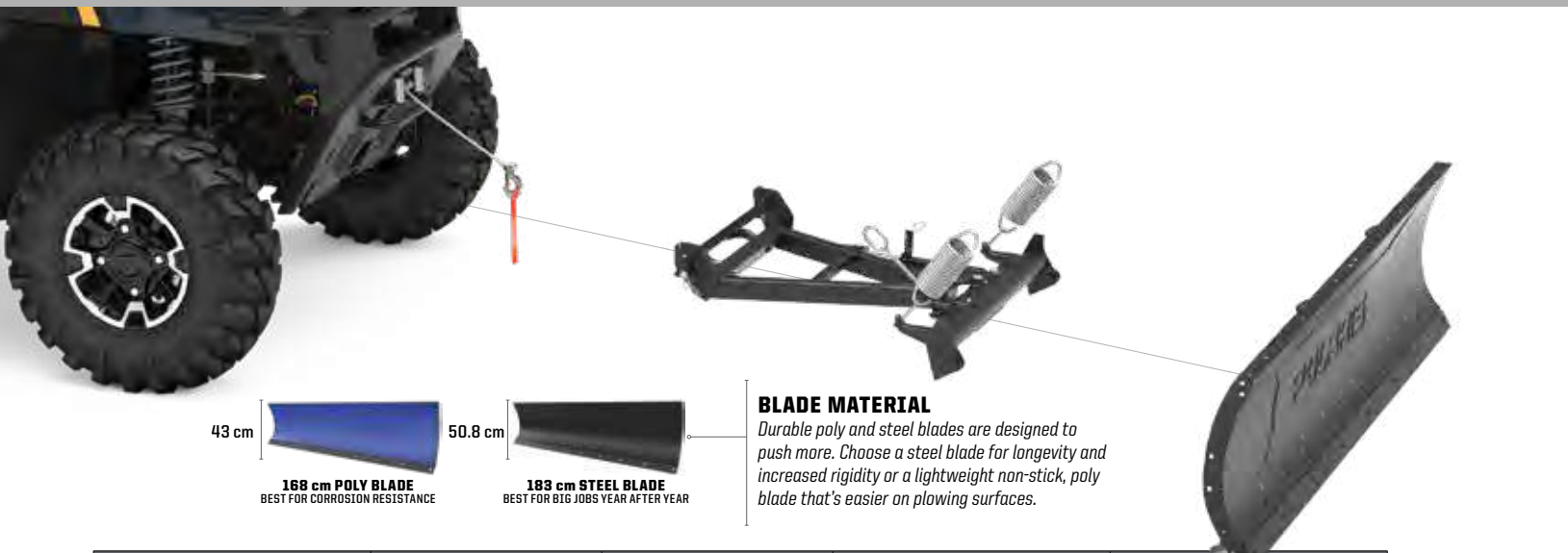

43 cm **168 cm POLY BLADE**
BEST FOR CORROSION RESISTANCE

50.8 cm **183 cm STEEL BLADE**
BEST FOR BIG JOBS YEAR AFTER YEAR

BLADE MATERIAL

Durable poly and steel blades are designed to push more. Choose a steel blade for longevity and increased rigidity or a lightweight non-stick, poly blade that's easier on plowing surfaces.

	STEP 1 SELECT A MOUNT	STEP 2 SELECT A FRAME	STEP 3 SELECT A LIFT METHOD	STEP 4 SELECT A BLADE
MODELS	MOUNT	FRAME	WINCHES	BLADES
XP 1000 '18-21 CREW XP 1000 '19-21 1000 '20-21 CREW 1000 '20-21 <small>NOT COMPATIBLE WITH 29" OR LARGER TIRES</small>	Not Required Integrated into Factory Brushguard <small>NON EPS RANGER 1000 REQUIRES FRONT BUMPER</small>	<small>TOP SELLER</small> 2882927 Replacement Shear Pin 2205527	Polaris HD 2,041 kg Winch 2882714	183 cm Steel 2880270 168 cm Poly 2880269 168 cm Steel 2880268

SELECT ACCESSORIES

WEAR BARS

- Protect your plow blade and minimize wear on the actual blade by installing Wear Bars
- » 183 cm • 2204976
- » 168 cm • 2879867
- » 152 cm • 2877243
- » HD 183 cm • 2879875
- » HD 168 cm • 2879868

PLOW BLADE SNOW DEFLECTOR

- » 183 cm • 2858541
- » 168 cm • 2879866
- » 152 cm • 2871808

HEAVY DUTY SNOW PLOW DEFLECTOR

- » 183 cm • 2884160

QUICK RELEASE SKID SHOES

- Helps prevent blade wear
- Hardened steel for industrial strength
- » 2208864



2-SEAT & CREW 570 FULL-SIZE & CREW

GLACIER HD

» **168 cm Blades**

» **Choice of poly or steel**



43 cm **168 cm POLY BLADE**
BEST FOR CORROSION RESISTANCE

43 cm **168 cm STEEL BLADE**
BEST FOR BIG JOBS YEAR AFTER YEAR

	STEP 1 SELECT A MOUNT	STEP 2 SELECT A FRAME	STEP 3 SELECT A LIFT METHOD	STEP 4 SELECT A BLADE
MODELS	MOUNT	FRAME	WINCHES	BLADES
570 FULL-SIZE '16-21 CREW 570 FULL-SIZE '16-21	2879105 2879106	TOP SELLER 2882927 Replacement Shear Pin 2205527	Polaris HD 1,588 kg Winch 2881669	168 cm Poly 2880269 168 cm Steel 2880268
570/500/ETX '10-21 CREW 570 '10-21 LI-ION EV & EV '15-21	2879105 2879106		Polaris HD 1,588 kg Winch 2881669	168 cm Poly 2880269 168 cm Steel 2880268

COIL SPRING SPACER

- Keep the front end of the vehicle up and improve ride quality when using a plow on strut or A-arm vehicles

» 2872655

QUICK RELEASE SKID SHOES

- Helps prevent blade wear
- Hardened steel for industrial strength

» 2208864

PLOW MARKER

- Helps driver monitor plow blade position
- Sold in pairs

» 2872726

GLACIER PLOW LINK

» 2204974

ADVANCED TECH

RIGID lights are driven by Aluminum PCB Smart Boards™, 6063-T5 aircraft aluminum extruded housings and Tiger Drylac UV protection polyester powdercoating.

EXCLUSIVE OPTICS

RIGID lights feature impact-resistant polycarbonate lenses for a 100% water/dustproof seal.

LIGHT BAR TYPES



SR-SERIES PRO

Sleek, powerful, low-profile (under 5 cm tall).
Lights extreme distances with low energy usage.
Available in 25 cm & 81 cm



D-SERIES PRO

Compact to fit almost anywhere with
high output and low energy usage.
Available in Driving, Flood & Spot

LIGHT BAR OPTIONS

OPTICS DRIVING FLOOD

1200 m									
960 m									
720 m									
480 m									
240 m									
BRAND	RIGID	RIGID	RIGID	PRO ARMOR	PRO ARMOR	PRO ARMOR	RIGID	RIGID	PRO ARMOR
SIZE	POD	25 cm	POD	25 cm	28 cm	CUBE	25 cm	POD	CUBE
TYPE	D-SERIES	SR-SERIES	D-SERIES	DUAL-ROW	SINGLE-ROW	DUAL-ROW	SR-SERIES	D-SERIES	DUAL-ROW
RAW LUMENS	4,752	7,920	3,168	3,780	1,890	1,400	7,920	3,168	1,400
PN	2883128	2883122	2883126	2882311	2882313	2882312	2883121	2883127	2882076
	Comes in a pair		Comes in a pair					Comes in a pair	

SPOT

1200 m			
960 m			
720 m			
480 m			
240 m			
BRAND	RIGID	RIGID	PRO ARMOR
SIZE	25 cm	POD	CUBE
TYPE	SR-SERIES	D-SERIES	DUAL-ROW
RAW LUMENS	7,920	3,168	1,400
PN	2883121	2883127	2882076
		Comes in a pair	

BUILD YOUR VISION

Consider the Optics, Angle & how you will use your vehicle to choose the right light or set of lights.

OPTICS LIGHT ANGLE	ACCENT	DRIVING (45°)	FLOOD (25°)	SPOT (10°)	COMBO (25°/10°)
DRIVING SPEED	All	Slow	Medium	Fast	Medium to fast
BEAM	Diffused glow	Extra-wide	Wide/Shorter	Concentrated/Long	Inner spot & outer flood
RECOMMENDED MOUNTING	Low/Wheel well	All points	Low &/or rear	High points	All points
TERRAIN & RIDING STYLE	Added style & personalization in any terrain	All riding & utility	Wide-open terrain or trails & utility	Trail & tight conditions	All riding & utility

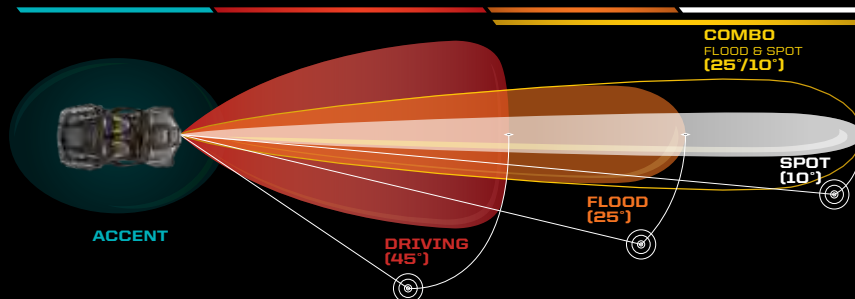

MAX PERFORMANCE
Validated to work as hard as your machine does.

DOESN'T OVERTAX
Trust it to work when you need it to.

PRO ARMOR®



COMMON

3-SEAT & CREW / 2-SEAT & CREW

COOLERS

HUNT

COLD WEATHER

PLOWS

LIGHTING

WHEELS & TIRES

RUGGED CONSTRUCTION

Pro Armor lights are designed to be big and beefy with an aggressive style all their own, and housed in IP67 marine-grade rated UV polyester powder coating.

MASSIVELY BRIGHT

Pro Armor builds bright lights designed for any riding experience. All that power is directed through heat dissipating aluminum for streamlined heat management.



DUAL-ROW LED LIGHT BARS

The most spread and farthest illumination downrange. Easy to mount.
Available in Cube, 25 cm, 50 cm & 76 cm



SINGLE-ROW LED LIGHT BARS

Powerful, compact, low-profile light bars with sleek look.
Available in 28 cm, 84 cm & 102 cm



CUBE LED LIGHTS

Small size allows mounting in strategic locations for added lighting.
Available in Flood & Spot

COMBO

OPTICS

1200 m
960 m
720 m
480 m
240 m

BRAND SIZE TYPE
RAW LUMENS
PN

PRO ARMOR	PRO ARMOR	RIGID	RIGID	PRO ARMOR	PRO ARMOR	PRO ARMOR	PRO ARMOR
25 cm	28 cm	81 cm	25 cm	76 cm	50 cm	102 cm	84 cm
DUAL-ROW	SINGLE-ROW	SR-SERIES	SR-SERIES	DUAL-ROW	DUAL-ROW	SINGLE-ROW	SINGLE-ROW
3,780	1,890	20,064	7,920	13,860	8,820	7,560	6,300
2882075	2882078	2884299	2883123	2882074	2883107	2882763	2882077

ADD A HARNESS TO MOUNT YOUR LIGHTS

MODEL	LIGHT BAR SET-UPS		
	1 LIGHT IN 1 LOCATION ON 1 SWITCH	2 LIGHTS IN 2 LOCATIONS ON 1 SWITCH	2 LIGHTS IN 2 LOCATIONS ON 2 SWITCHES
2014-2021 ALL MODELS EXCEPT XP 1000 '18-21, CREW XP 1000 '19-21, 1000 '20-21 & CREW 1000 '20-21	⚠ Requires Battery Connection Cable LIGHT BAR HARNESS 2882209	⚠ Requires Battery Connection Cable LIGHT BAR HARNESS 2882209 Y-HARNESS 2879860	⚠ Requires Battery Connection Cable LIGHT BAR HARNESS (x2) 2882209
XP 1000 '18-21, CREW XP 1000 '19-21, 1000 '20-21 & CREW 1000 '20-21	SEE P. 29 FOR WIRING CONNECTIONS		

IF INSTALLING REAR FACING LIGHT ON CREW MODELS, USE 2883854

1 LED LIGHT BAR WIRING HARNESS - REAR FACING CREW EXTENSION

» 2883854

XP 1000 '20-21, DIESEL '19-21, CREW XP 1000 '19-21, CREW 1000 '20-21

ADD A BEACON LIGHT FOR 360° ILLUMINATION P. 35



BATTERY CONNECTION CABLES

3-SEAT & CREW

- » 3-SEAT • 2879388
XP 1000 '17-18, DIESEL '19-21, XP 900 '19
- » CREW • 2879685
CREW XP 900/CREW XP 1000 '17-18

2-SEAT & CREW

- » 2-SEAT • 2879990
570 '15-21, 500 '17-21
- » CREW • 2880929
CREW 570-4 '15-21, 570 '15-21, 500 '17-21
- » 570 • 2881684
570 FULL-SIZE '16-21

RANGER INDICATOR KIT

• Includes wiring, switch, 4 x LED lights and flasher kit

» AUST313
FITS ALL RANGERS

LED AMBER FLASHING LIGHT

» AUST393
FITS ALL RANGERS



RANGER 570 FULL-SIZE

PLEASE NOTE, NOT FOR MID SIZE (2 SEATER)
RANGER 500 & 570

PERFORMANCE & COMFORT

THE RANGER 570 FULL-SIZE builds on its legendary reputation for getting the job done. With the industry's most complete lineup of Polaris Engineered Accessories, it's ready for anything your work demands.



ROOFS



SPORT ROOF

- Lightweight, rugged polyethylene construction
- Offers protection from sun and rain
- Does not work with Full Doors

» **TOP SELLER** 2877946

570 FULL SIZE '17-21

» **CREW** • 2878755

CREW 570 FULL SIZE '18-21



BIMINI SOFT TOP

- Tight-fitting canvas soft top with easy on/off design
- Lightweight 600 denier, solution-dyed polyester construction

» 2876963-067

570 FULL SIZE '17-21

ROOF/REAR PANEL



CANVAS ROOF/REAR PANEL

- Constructed from premium, mold-resistant polyester with UV stabilizers
- Durable, heat-sealed vinyl window for crack resistance

» 2883471

570 FULL SIZE '17-21

WINDSHIELDS



POLY WINDSHIELD

- Optical-grade, .6 cm-thick polycarbonate for outstanding protection and visibility

» **HARD COAT** • 2879489

CREW 570 FULL SIZE '18-21

» **TOP SELLER** **GENERAL PURPOSE** • 2876958

CREW 570 FULL SIZE '18-21, 570 FULL SIZE '17-21



LOCK & RIDE HALF WINDSHIELD

- Durable, optical-grade, .45 cm-thick polycarbonate for impact-resistance
- Half-height design delivers improved airflow for hot/dusty conditions
- Retains sporty, rugged look

» 2878756

CREW 570 FULL SIZE '18-21, 570 FULL SIZE '17-21

REAR PANEL



POLY REAR PANEL

- Constructed from thick, impact resistant polycarbonate
- Delivers protection from the elements and a quieter ride
- Scratch-resistant for years of clear vision
- Contoured design eliminates perimeter framework for full rearward visibility

» 2878165

CREW 570 FULL SIZE '18-21, 570 FULL SIZE '17-21

LOCK & RIDE

ADD STORAGE TO YOUR RANGER 570 **P. 48**



DO MORE

COOLERS

SEE P. 194



HUNT

SEE P. 52



COLD WEATHER

SEE P. 48

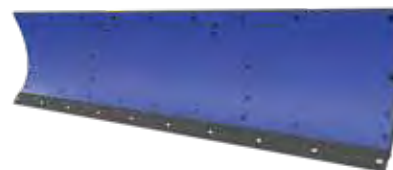

LIGHTING

SEE P. 60



DOORS



RANGER CANVAS DOORS

- Constructed from premium, mold-resistant polyester with UV stabilizers
- Durable, heat-sealed vinyl window for crack resistance
- Zip-down windows for adjustable ventilation

» 2876962-067

570 FULL SIZE '17-21
REQUIRES 2883471 CANVAS ROOF/REAR PANEL
DOES NOT FIT WITH 2877946
OR 2876963-067

PROTECTION



BRUSHGUARDS

- Provides front impact resistance and headlight protection
- Durable, scratch-resistant black powder coated finish

» FRONT • 2881662

CREW 570 FULL SIZE '18-21, 570 FULL SIZE '17-21



HORN

» 2875048

570 FULL SIZE '17-21

REVERSE BEEPER

» 2880631

CREW 570-4 '15-21,
570 '15-21, 500 '17-21

WINCHES

FEATURES	PRO PRO HEAVY DUTY SERIES	HD HEAVY DUTY SERIES	
RAPID ROPE RECOVERY	STANDARD	NOT AVAILABLE	
AUTO STOP TECHNOLOGY	STANDARD	OPTION	
WINCH LINE	SYNTHETIC ROPE	STEEL CABLE	
FAIRLEAD	ALUMINUM	STEEL ROLLER	
CONTROL	WIRELESS STANDARD, WIRED OPTION	WIRED STANDARD, WIRELESS OPTION	
MODEL	2,041 kg	1,588 kg	ADD REQUIRED CABLES
570 FULL-SIZE '16-21 CREW 570 FULL-SIZE '16-21	2882238	TOP SELLER 2881669	3-Seat Models: 2881684 Crew Models: 2880929

UPGRADE YOUR HD WINCH WITH THESE ACCESSORIES

WIRELESS REMOTE	SYNTHETIC ROPE	AUTO STOP UPGRADE
<ul style="list-style-type: none"> • Up to 15 m range with LED indicator • Direct plug and play operation » 2879316 Works with 2881669	1,588 kg » 2878888 1,588 kg » 2879187 STEEL CABLE 1,588 kg » 2878890	<ul style="list-style-type: none"> • Billeted aluminum • Replaces stock fairlead » 2881693 Works with 2881669 SYNTHETIC ROPE REQUIRED

UPGRADE YOUR CONTROLS HD OR PRO HD WINCHES

WIRED REMOTE CONTROL	POWER CONTROLLER
<ul style="list-style-type: none"> • Must order remote handle and socket together » REMOTE HANDLE 4013466 » SOCKET 4014228	<ul style="list-style-type: none"> • Control your winch and plow hydraulics directly from the shift knob » 2879227 EV '11-21, CREW 570-4 '14-21, 570 FULL SIZE '17-21, 570 '14-21, 500 '11-21

TIRES



FRONT/REAR

KANATI MONGREL

TOP SELLER

- Tread optimized for peak performance on multiple surfaces.
- Handles a variety of off-road terrain while remaining equally safe and suitable for paved surfaces.
- Greater puncture resistance with a 10 ply carcass with smooth handling due to the re-engineered sidewall
- The all new 10-ply, DOT approved radial also boasts an impressive 1,000 lb. load rating and an equally impressive 87 MPH "N" speed rating.

	SIZE		PLY RATING	FITMENT
↑ 12" ↓	27" x 9" R12 AE122709MG	FRONT	10	RANGER FULLSIZE
↑ 12" ↓	27" x 11" R12 AE122711MG	REAR		



WHEEL SIZE



MID SIZE RANGER 570 / 500 / EV

MAKE IT YOURS



RANGER 570
WORK



RANGER 500
WORK

2-SEAT & CREW

570/500/EV

ROOFS & DOORS

WINDSHIELDS
& REAR PANELS

CONVENIENCE
& PROTECTION

WINCHES

STORAGE

LIGHTING

TIRES

2882178	Flip-down Poly Windshield	P. 68
2879812	Rear Poly Panel	P. 69
2883236	Poly Sport Roof	P. 66

ROOFS



**SEALED
COVERAGE**



**REDUCE
STANDING
WATER**



LOCK & RIDE

**EASY AND FAST
INSTALLATION**

POLY **VS** STEEL

- Water run-off
- Mounting features: easily add accessories & lighting
- Liner ready
- Lightweight

- Heavy duty/durable
- Low profile
- Unique style

SHIELD AGAINST DRIVING RAIN OR THE BLISTERING SUN. Choose from poly or steel and know that you are protected from the elements with a seamless integrated roof.

POLY Lightweight, durable and impact-resistant. A poly roof can take the abuse of a tight trail and still protect.



SPORT ROOF - POLY

- Provides shade, superior overhead protection
- Tough injection-molded design resists distortion from the elements
- Polaris Pursuit Camo offers effective visual camouflage in the field

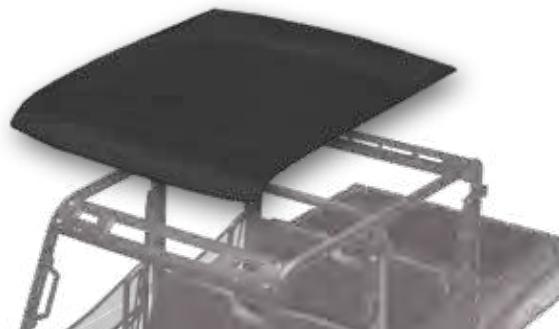

» 2-SEAT POLARIS PURSUIT CAMO • 2883237

EV '15-21, 570 '15-21, 500 '17-21

» **TOP SELLER** 2-SEAT BLACK • 2883236

EV '15-21, 570 '15-21, 500 '17-21

» CREW BLACK • 2883238

CREW 570-4 '15-21

STEEL For the ultimate in strength and protection.

HD ROOF - STEEL

- Stout 12-gauge steel construction
- Powdercoated finish for scratch and corrosion resistance
- Interior fabric liner provides sound reduction

» 2-SEAT • NLA

EV '15-21, 570 '15-21, 500 '17-21



DOORS

POLARIS ENGINEERED ADVANTAGES



PREMIUM FEATURES



UNPRECEDENTED VENTILATION OPTIONS



EASY AND FAST INSTALLATION

	POLY DOORS	CANVAS DOORS	STEEL HALF DOORS
FRONT DOORS (SET OF 2) EV '15-'21, CREW '570-4 '15-'21, 570 '15-'21, 500 '17-'21	<p>HINGED WINDOW</p> <ul style="list-style-type: none"> A premium, door offering hinged window for customizable ventilation in the cab.  <p>Hinged Window - Poly Doors - Black 2882247</p>	<p>ZIP WINDOW</p> <ul style="list-style-type: none"> Lightweight, durable protection with adjustable zipper ventilation and see-through bottom panel.  <p>Zip Window Doors - Canvas - Black 2879963</p>	<p>HEAVY DUTY STEEL</p> <ul style="list-style-type: none"> Designed for protection from anything thrown at you.  <p>Steel Doors - Half AUST510</p>
REAR DOORS (SET OF 2) CREW '570-4 '15-'21		 <p>Zip Window Doors - Rear - Canvas - Black 2879964</p>	



WINDSHIELDS & REAR PANELS

GLASS VS POLY

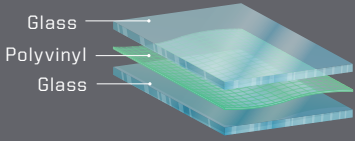

- Superior optical clarity (automotive level)
- Scratch-resistant
- Curved to fit, seals tight
- Cold weather/ heavy duty
- Wiper ready (Windshield only)

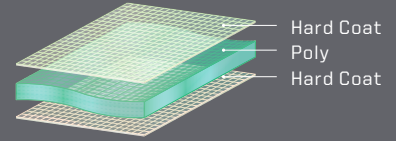

- Lightweight, flexible, easy to store/remove
- Impact-resistant
- Tight seal keeps out rain and dust

WINDSHIELDS



LOCK & RIDE TIP-OUT WINDSHIELD - GLASS

- Made of strong, optical-grade laminate safety glass
- Provides optimal visibility and the best protection from wind, inclement weather and off-road hazards
- Minimal perimeter framework for a low profile and full visibility
- Tip-out feature adjusts the windshield to an open position to enjoy airflow in the cab

» 2881784

EV '15-21, CREW 570-4 '15-21, 570 '15-21, 500 '17-21

FULL WINDSHIELD - GLASS TOP SELLER

- Provides the highest level of scratch resistance

» 2881783

EV '15-21, CREW 570-4 '15-21, 570 '15-21, 500 '17-21



FLIP-DOWN WINDSHIELD - HARD COAT POLY TOP SELLER

- 2 venting options: fully sealed or flip-down/remove upper half for some protection with maximum ventilation

» 2882178

EV '15-21, CREW 570-4 '15-21, 570 '15-21, 500 '17-21



LOCK & RIDE VENTED WINDSHIELD - HARD COAT POLY

- Frameless design for maximum visibility
- Added vents for airflow on a hot day or defrosting on a cold day

» 2883342

EV '15-21, CREW 570-4 '15-21, 570 '15-21, 500 '17-21



LOCK & RIDE FULL WINDSHIELD - HARD COAT POLY TOP SELLER

- Durable, optical-grade, 0.6 cm-thick polycarbonate offers outstanding rider protection and visibility
- Windshield has minimal perimeter framework for full visibility

» 2883319

EV '15-21, CREW 570-4 '15-21, 570 '15-21, 500 '17-21

HARD COAT POLY // 30X MORE SCRATCH RESISTANT



LOCK & RIDE

REVOLUTIONARY INSTALLATION

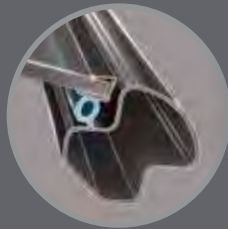

AIRTIGHT GASKET SEAL



VENTING OPTIONS

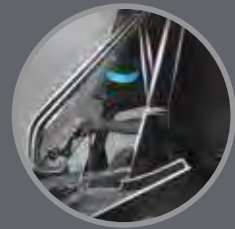

MULTI-FUNCTION FEATURES



LOCK & RIDE FULL WINDSHIELD - POLY TOP SELLER

- Durable, optical-grade, 0.6 cm-thick polycarbonate offers outstanding rider protection and visibility
- Windshield has minimal perimeter framework for full visibility

» 2883318

EV '15-21, CREW 570-4 '15-21, 570 '15-21, 500 '17-21



LOCK & RIDE HALF WINDSHIELD - POLY

- Strong, durable polycarbonate half windshield delivers a combination of protection and airflow into the cab
- Half windshield offers protection from rain, sleet, spray, and off-road hazards

» 2883320

EV '15-21, CREW 570-4 '15-21, 570 '15-21, 500 '17-21

REAR PANELS



LOCK & RIDE REAR PANEL - GLASS

- Durable, tempered laminate glass provides a high level of scratch resistance

» 2879965

EV '15-21, CREW 570-4 '15-21, 570 '15-21, 500 '17-21



LOCK & RIDE REAR PANEL - POLY TOP SELLER

- Strong, 0.6 cm-thick polycarbonate provides outstanding impact and scratch resistance

» 2879812

EV '15-21, CREW 570-4 '15-21, 570 '15-21, 500 '17-21



REDUCE IN-CAB DUST SWIRL BY ADDING A REAR PANEL

With a windshield and roof installed, turbulent air develops behind the cab. Add a rear panel to reduce dust intrusion from this swirl.

CONVENIENCE & PROTECTION

CONVENIENCE FEATURES

CAB SEAL SYSTEM

» 2 SEAT • 2880508

EV '15-21, CREW 570-4 '15-21, 570 '15-21, 500 '17-21

(INCLUDED WITH PREMIUM DOORS)

EPS SYSTEM (ELECTRIC POWER STEERING)

- Enjoy smooth, easy, precise, responsive automotive-quality power steering
- EPS provides a light steering feel in all situations, including low-speed maneuvering through challenging terrain

» 2879970

CREW 570-4 '15-21, 570 '15-21
1824163 REQUIRED FOR 2016
AND NEWER 570 MODELS

HORN

» 2879273

EV '15-21, CREW 570-4 '15-21, 570 '15-21, 500 '17-21

AUXILIARY BATTERY KIT

» 2880555

EV '15-21
REQUIRED FOR 12V ACCESSORIES ON EV

REVERSE WARNING ALERT

» 2880631

CREW 570-4 '15-21, 570 '15-21, 500 '17-21

SPEEDKEY

» 2879988

CREW 570-4 '15-21, CREW 1000 '20-21, 570 '15-21

EV QUICK CHARGING SYSTEM

» 2880556

EV '15-21



FIELD TESTED INTERIOR

ADD SUPERIOR ALL-WEATHER FUNCTIONALITY and comfort to your RANGER with premium Polaris Engineered Accessories. Keep warm on the coldest of days with a heater kit and improve visibility with a Windshield Wiper and Washer System or Large Rear View Mirror.



8-VENT HEATER & DEFROST SYSTEM

» 2879967

CREW 570-4 '15-21, 570 '15-21

⚠ Requires Battery Connection Cable



LARGE REAR VIEW MIRROR

TOP SELLER

» 2879969

CREW 570-4 '15-21, CREW 1000 '20-21, 570 '15-21, 500 '17-21



KOLPIN RANGER SIDE MIRROR KIT

- Fits all mid and full size Rangers
- Dual-view lenses for wide viewing range
- Rugged fold-in and break-away design
- Included clamps fit 1 5/8" - 2" round tubing for profile tubes
- Low profile clamp compatible with most windshields and doors
- Package includes a set of two mirrors
- Mirror Dimensions: 3.5"W x 10"H

» 98315

ALL RANGER AND RZR570
FITS FULL DOORS, SEE POLARIS ACCESSORIES
TEAM FOR INSTRUCTIONS



FOLDING SIDE MIRRORS

- Will not work with full doors fitted

» EMP-11969

15-21 570 & 15-21 500



WINDSHIELD WIPER & WASHER SYSTEM

- Use with Full Glass Windshield 2881783 only

» 2879968

EV '15-21, CREW 570-4 '15-21, 570 '15-21, 500 '17-21

⚠ Requires Battery Connection Cable

STANDARD BRUSHGUARDS

PERFECT FOR: **INCREASED PROTECTION AROUND LIGHTING AND FENDERS**

FRONT



3.2CM DIAMETER
STEEL TUBE CONSTRUCTION

REAR



» FRONT • 2879973

» REAR • 2879972

500 '17-21, 570 '15-21, CREW 570-4 '15-21, EV '15-21

2879973 DOES NOT WORK WITH FLIP-DOWN POLY WINDSHIELD 2881919

ROCK GUARDS WITH STEP

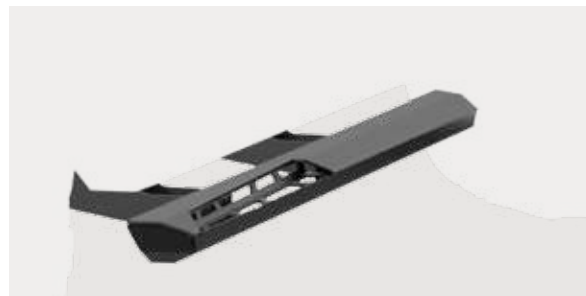

- Durable, stamped plate steel construction
- Provides additional protection for side of vehicle
- Integrated boot scraper helps keep interior clean

» 2 SEAT • 2879974

500 '17-21, 570 '15-21, EV '15-21





REAR SPLASH GUARDS

» AUST404

500 17-21, 570 MY15-21

WINCHES

FEATURES	PRO PRO HEAVY DUTY SERIES	HD HEAVY DUTY SERIES	
RAPID ROPE RECOVERY	STANDARD	NOT AVAILABLE	
AUTO STOP TECHNOLOGY	STANDARD	OPTION	
WINCH LINE	SYNTHETIC ROPE	STEEL CABLE	
FAIRLEAD	ALUMINUM	STEEL ROLLER	
CONTROL	WIRELESS STANDARD, WIRED OPTION	WIRED STANDARD, WIRELESS OPTION	
MODEL	2,041 kg	1,588 kg	ADD REQUIRED CABLES
570 '15-21 CREW 570-4 '15-21 500 '17-21 RANGER EV '19-21 REQUIRES AUXILIARY BATTERY KIT 2880555	 2882238	 2881669	2-Seat Models: 2879990 Crew Models: 2880929

UPGRADE YOUR HD WINCH WITH THESE ACCESSORIES

WIRELESS REMOTE <ul style="list-style-type: none"> • Up to 15 m range with LED indicator • Direct plug and play operation » 2879316 Works with 2881669	SYNTHETIC ROPE 2,041 kg » 2879187 1,588 KG » 2878888	AUTO STOP UPGRADE <ul style="list-style-type: none"> • Billeted aluminum • Replaces stock fairlead » 2881693 Works with 2881669 SYNTHETIC ROPE REQUIRED
---	---	---

UPGRADE YOUR CONTROLS HD OR PRO HD WINCHES

WIRED REMOTE CONTROL <ul style="list-style-type: none"> • Must order remote handle and socket together. » REMOTE HANDLE 4013466 » SOCKET 4014228	POWER CONTROLLER <ul style="list-style-type: none"> • Control your winch and plow hydraulics directly from the shift knob » 2879227 EV '11-21, CREW 570-4 '14-21, 570 FULL SIZE '17-21, 570 '14-21, 500 '11-21
--	--

ULTIMATE PROTECTION



BULL BAR AND SIDE RAIL KIT

» AUST517

500 MY17-21, 570 HD MY15-21



RANGER 500 & 570 MUD GUARD KIT

» AUST528

500 MY17-21, 570 HD MY15-21, 570 CREW MY15-21

ALLOY PROTECTION



ALUMINIUM FRONT A-ARM GUARDS

» AUST316 | PAIR

500 MY17-21, 570 HD MY15-21, 570 CREW MY15-21

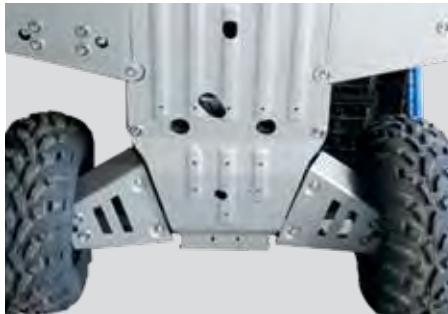

ALUMINIUM REAR A-ARM GUARDS

» AUST366 | PAIR

500 MY17-21, 570 HD MY15-21, 570 CREW MY15-21



FULL ALLOY SKID PLATE KIT WITH A-ARMS TOP SELLER

» AUST512

500 MY17-21, 570 HD MY15-21

SEAT COVERS

BENCH SEAT

» P772Q

500 MY17-21, 570 HD MY15-21, EV 15-21

BUCKET SEAT

» AUST405

570 HD 15-21, EV 15-21



WINDSHIELD & REAR PANELS



EV BATTERY FILL KIT

- Single point watering system
- Keep EV batteries topped up to prevent failure
- Requires x 2
- » BGU48V4G - Also requires BAMS630

EV '15-21



HAND PUMP

- For Fill Kit
- » BAMS630



SNORKEL KIT

Kit contents: Snorkel, Template and Instructions

Additional material required: 1x 8mm bolt and 8mm nut. Not required if unit is fitted with doors

- » AUST407

500 17-21, 570 HD 15-21

STORAGE



LOCK & RIDE

EXCLUSIVE AND AVAILABLE ON ALL POLARIS VEHICLES, LOCK & RIDE ACCESSORIES LET YOU QUICKLY CHANGE FROM ONE TASK TO ANOTHER WITH HUNDREDS OF OPTIONS.

WITH THE FLIP OF A LEVER, LOCK & RIDE PLUNGERS USE OUTWARD PRESSURE TO EXPAND FOR A SECURE FIT.



LOCK & RIDE CARGOMAX SYSTEM

- Comes standard with a support bar that ties the two sides together for a sturdy cargo hold
- Adjustable utility hooks provide more options for hanging tools, cords or gear
- Two sides and a support bar included

» 2882177

EV '15-21, CREW 570-4 '15-21, CREW 570 FULL SIZE '18-21, 570 FULL SIZE '17-21, 570 '15-21, 500 '17-21,





CARGO BED MAT

- Non-slip surface to better secure loads
- Protect the cargo bed from scratches and scuffs
- Lifts out and is easy to clean
- Can be cut to access factory tie-down cleats

» 2881485

EV '11-21, CREW 570-4 '14-21, 570 '14-21, 500 '11-21



LOCK & RIDE STORAGE BOX

- Rugged roto-molded construction locks for security and is water-resistant
- Low-profile design retains additional hauling capacity on top of vault
- Sliding drawer features foam padding and adjustable dividers
- Fits perfectly in the bed of your RANGER, pickup box or full-size SUV

» 2877033

EV '11-21, CREW 570-4 '14-21, 570 '14-21, 500 '11-21



FIRE EXTINGUISHER HOLDER

- Quick-release strap allows for easy access

» 2882158

EV '15-21, CREW 570-4 '15-21, CREW 1000 '20-21, 570 '15-21, 500 '17-21



UNDER SEAT STORAGE BOX

» 2880046

EV '15-21, CREW 570-4 '15-21, 570 '15-21, 500 '17-21



LOCK & RIDE TOOL RACK

- Attach on the inside or outside of the cargo bed

» 2881533

EV '11-21, CREW 570-4 '14-21, CREW 570 FULL SIZE '18-21, 570 FULL SIZE '17-21, 570 '14-21, 500 '11-21

RIDE & REPAIR ESSENTIALS KIT

» 2881207

EV '11-21, CREW 570-4 '14-21, CREW 570 FULL SIZE '18-21, 570 FULL SIZE '17-21, 570 '14-21, 500 '11-21



LOCK & RIDE D-RINGS

- The most versatile Lock & Ride accessory - add as many as you need to secure your cargo with bungee cords or straps

» 2881545

EV '11-21, CREW 570-4 '14-21, CREW 570 FULL SIZE '18-21, 570 FULL SIZE '17-21, 570 '14-21, 500 '11-21



LOCK & RIDE CHAINSAW MOUNT

» 2879354

EV '11-21, CREW 570-4 '14-21, CREW 570 FULL SIZE '18-21, 570 FULL SIZE '17-21, 570 '14-21, 500 '11-21



LOCK & RIDE TOOL RACK

- Attach on the inside or outside of the cargo bed

» 2881533

EV '11-21, CREW 570-4 '14-21, CREW 570 FULL SIZE '18-21, 570 FULL SIZE '17-21, 570 '14-21, 500 '11-21

STRAPS

3.8 cm x 4.6 m 2494.8 kg RATCHET STRAP

- Heavy duty webbing
- 2 Pack

» 2884031



LOCK & RIDE QUICKSTRAP

- The quickest and most secure way to mount Polaris accessories

- Sold as a pair

» 2882187

ALL COOLERS, RANGER CARGO BOXES



5.1 cm x 6.1 m 4535.9 kg RATCHET STRAP

- Heavy duty webbing

» 2884032



DO MORE

COOLERS
SEE P. 190



HUNT
SEE P. 52



TOW & HAUL
SEE P. 50



LIGHTING
SEE P. 60



TIRES



FRONT/REAR

KANATI MONGREL

TOP SELLER

- Tread optimized for peak performance on multiple surfaces.
- Handles a variety of off-road terrain while remaining equally safe and suitable for paved surfaces.
- Greater puncture resistance with a 10 ply carcass with smooth handling due to the re-engineered sidewall
- The all new 10-ply, DOT approved radial also boasts an impressive 1,000 lb. load rating and an equally impressive 87 MPH "N" speed rating.

	SIZE		PLY RATING	FITMENT
↑ 12" ↓	25" x 8" R12 AE122508MG	FRONT	10	RANGER MIDSIZE
↑ 12" ↓	25" x 10" R12 AE122510MG	REAR		



WHEEL SIZE



MAX PERFORMANCE
Validated to work as hard as your machine does.

DOESN'T OVERTAX
Trust it to work when you need it to.

PRO ARMOR®



RUGGED CONSTRUCTION

Pro Armor lights are designed to be big and beefy with an aggressive style all their own, and housed in IP67 marine-grade rated UV polyester powder coating.

MASSIVELY BRIGHT

Pro Armor builds bright lights designed for any riding experience. All that power is directed through heat dissipating aluminum for streamlined heat management.



DUAL-ROW LED LIGHT BARS

The most spread and farthest illumination downrange. Easy to mount.
Available in Cube, 25 cm, 50 cm & 76 cm



SINGLE-ROW LED LIGHT BARS

Powerful, compact, low-profile light bars with sleek look.
Available in 28 cm, 84 cm & 102 cm



CUBE LED LIGHTS

Small size allows mounting in strategic locations for added lighting.
Available in Flood & Spot

SPOT

COMBO

OPTICS

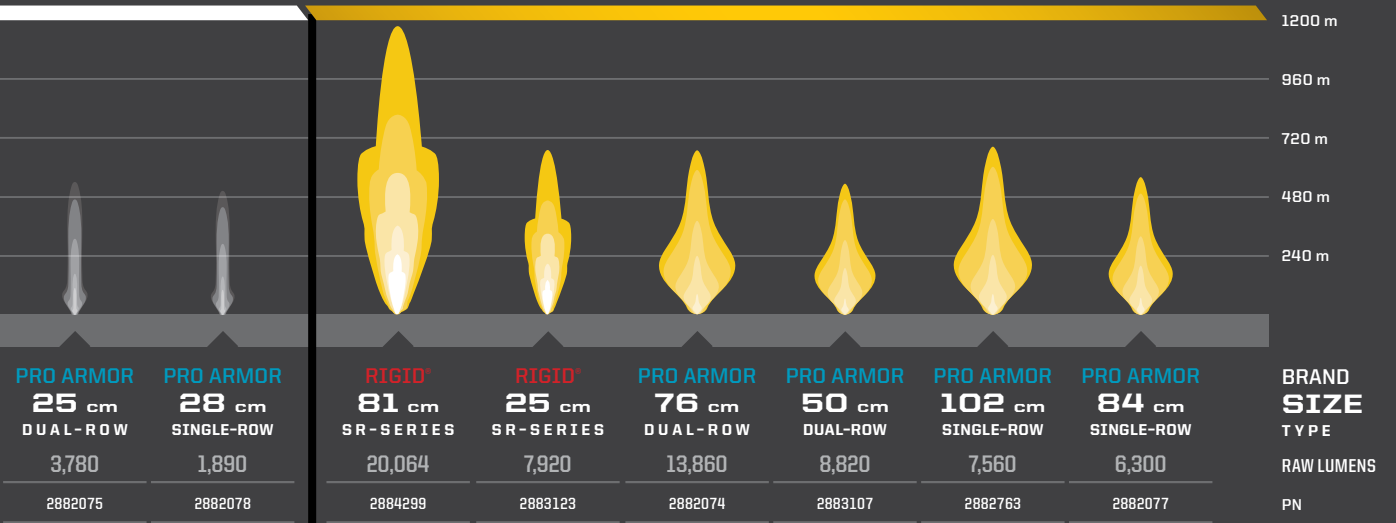

ADD A HARNESS TO MOUNT YOUR LIGHTS

MODEL	LIGHT BAR SET-UPS		
	1 LIGHT IN 1 LOCATION ON 1 SWITCH	2 LIGHTS IN 2 LOCATIONS ON 1 SWITCH	2 LIGHTS IN 2 LOCATIONS ON 2 SWITCHES
2014-2020 ALL MODELS WITHOUT POLARIS PULSE	Requires Battery Connection Cable LIGHT BAR HARNESS 2882209	Requires Battery Connection Cable LIGHT BAR HARNESS 2882209 Y-HARNESS 2879860	Requires Battery Connection Cable LIGHT BAR HARNESS (x2) 2882209
XP 1000 '18-20, CREW XP 1000 '19-20, 1000 '20 DIESEL '19-20	LIGHT BAR HARNESS 2883230	LIGHT BAR HARNESS 2883230 Y-HARNESS 2879860	LIGHT BAR HARNESS (x2) 2883230 (x2)

IF INSTALLING REAR FACING LIGHT ON CREW MODELS, USE 2883854

1 LED LIGHT BAR WIRING HARNESS - REAR FACING CREW EXTENSION

» 2883854
CREW XP 1000 '19-20

ADD A BEACON LIGHT FOR 360° ILLUMINATION
P. 35



BATTERY CONNECTION CABLES

3-SEAT & CREW **2-SEAT & CREW**

- » 3-SEAT • 2879388
XP 900 '13-19, XP 1000 '17-18, DIESEL '14-18
- » 2-SEAT • 2879990
570 '15-20, 500 '17-20
- » CREW • 2879685
CREW XP 900 '14-19, CREW XP 1000 '17-18
- » CREW • 2880929
CREW 570-4 '15-20, 570 '15-20, 500 '17-20

RANGER INDICATOR KIT

• Includes wiring, switch, 4 x LED lights and flasher kit

» AUST313
FITS ALL RANGERS

LED AMBER FLASHING LIGHT

» AUST393
FITS ALL RANGERS



2-SEAT & CREW

570/500/EV

ROOFS & DOORS

WINDSHIELDS & REAR PANELS

CONVENIENCE & PROTECTION

WINCHES

STORAGE

LIGHTING

TIRES